

EPSON® PowerLite® Cinema 200
Home Theater Projector

User's Guide

Copyright Notice

All rights reserved. No part of this publication may be reproduced, stored in a retrieval system, or transmitted in any form or by any means, electronic, mechanical, photocopying, recording, or otherwise, without the prior written permission of SEIKO EPSON CORPORATION. The information contained herein is designed only for use with this EPSON product. EPSON is not responsible for any use of this information as applied to other products.

Neither SEIKO EPSON CORPORATION nor its affiliates shall be liable to the purchaser of this product or third parties for damages, losses, costs, or expenses incurred by purchaser or third parties as a result of: accident, misuse, or abuse of this product or unauthorized modifications, repairs, or alterations to this product, or (excluding the U.S.) failure to strictly comply with SEIKO EPSON CORPORATION's operating and maintenance instructions.

SEIKO EPSON CORPORATION shall not be liable for any damages or problems arising from the use of any options or any consumable products other than those designated as Original EPSON Products or EPSON Approved Products by SEIKO EPSON CORPORATION.

EPSON is a registered trademark of SEIKO EPSON CORPORATION.

EPSON Extra Care, EPSON Connection and EPSON Store are service marks, and PrivateLine and PowerLite are registered trademarks of Epson America, Inc.

Pixelworks and DNX are trademarks of Pixelworks, Inc.

General Notice: Other product names used herein are for identification purposes only and may be trademarks of their respective owners. EPSON disclaims any and all rights in those marks.

Contents

Introduction	7
Registration and Warranty	7
Projector Parts	8
Projection Controls	9
Optional Accessories	10
Using This Manual	11
Getting More Information	11
Setting Up the Projector	13
Choosing a Location	13
Connecting the Cables	15
Other Connections	16
Displaying and Adjusting the Image	17
Focusing and Zooming the Image	17
Inverting and Mirroring the Image	18
Selecting the Input Signal Setting	18
Positioning the Image	19
Performing Keystone Correction	19
Basic Operation	21
Turning On the Projector	21
Turning the Projector Off	22
Selecting the Image Source	22
Choosing the Aspect Ratio	23
Choosing the Color Mode	24
Locking the Projector	25

Making Adjustments	27
Using the Menu System	27
Changing How the Menu Displays	28
Adjusting the Image Quality	29
Brightness and Contrast Settings	29
Sharpness and Picture Quality Settings	30
Color Settings	31
Adjustments for Computer Images	32
Saving and Resetting Menu Selections	33
Creating Memory Settings	33
Resetting the Projector	34
Customizing Projector Features	35
Image Sizing	35
Screen Options	36
Other Setup Options	36
Using Cinema Color Editor	39
Setting Up Your Computer	39
System Requirements	39
Installing the Software	40
Connecting to the Computer	41
Using Cinema Color Editor	42
Remote Control Operations	43
Adjusting the Picture Quality	44
Adjusting the Color	45
Saving and Recalling Picture Settings	46
Managing Your Settings	48

Maintenance	49
Cleaning the Lens	49
Cleaning the Projector Case	49
Changing the Remote Control's Batteries	50
Cleaning and Replacing the Air Filter	51
Replacing the Lamp	52
Resetting the Lamp Usage Timer	53
Storing the Projector	54
Transporting the Projector	54
Problem Solving	55
What To Do When the Lights Flash	55
Checking the Projector Status	56
Solving Picture Problems	57
Solving Remote Control Problems	60
Where To Get Help	61
Specifications	63
General	63
Lamp	63
Remote Control	63
Dimensions	64
Electrical	64
Environmental	64
Safety	64
Compatible Video Formats	65
Aspect Ratio Settings	66

Notices	69
Important Safety Information	69
Remote Control Information	70
FCC Compliance Statement	71
Declaration of Conformity	72
Epson America, Inc., Limited Warranty	72
Index	75

Introduction

The EPSON® PowerLite® Cinema 200 projector lets you enjoy theater-quality images in the relaxing environment of your own home. Designed especially for home cinema use, it offers these outstanding features:

- 1280 × 720 resolution, 800:1 contrast ratio, and up to 1300 lumens for incredibly rich, sharp images
- Pixelworks™ Digital Natural Expression™ technology to make fast-moving images appear clear and lifelike
- True 16:9 wide-format projection
- Flexible setup configurations, including front or rear projection and ceiling mounted, with a screen trigger port to automatically raise and lower your projection screen
- Vertical and horizontal lens shift to position the image without distortion
- Adjustable color modes to quickly optimize viewing for different lighting environments, and Cinema Color Editor software for making fine custom color adjustments
- Electronic zoom and focus for precise image adjustment
- Parental control using the projector's child lock

Registration and Warranty

The EPSON PowerLite Cinema 200 comes with a basic two-year carry-in warranty. For details, see page 72.

In addition, for customers who register their projector, EPSON offers free Extra CareSM Home Service. In the unlikely event of an equipment failure, you won't have to wait for your unit to be repaired. Instead, EPSON will ship you a replacement unit anywhere in the United States or Canada, usually via overnight delivery. See your *Extra Care Home Service* brochure for details.

To register, simply fill out the registration card that came with your projector and mail it to EPSON. Or you can register online at <http://www.epson.com/webreg>. Registering also lets you receive special updates on new accessories, products, and service.

Projector Parts

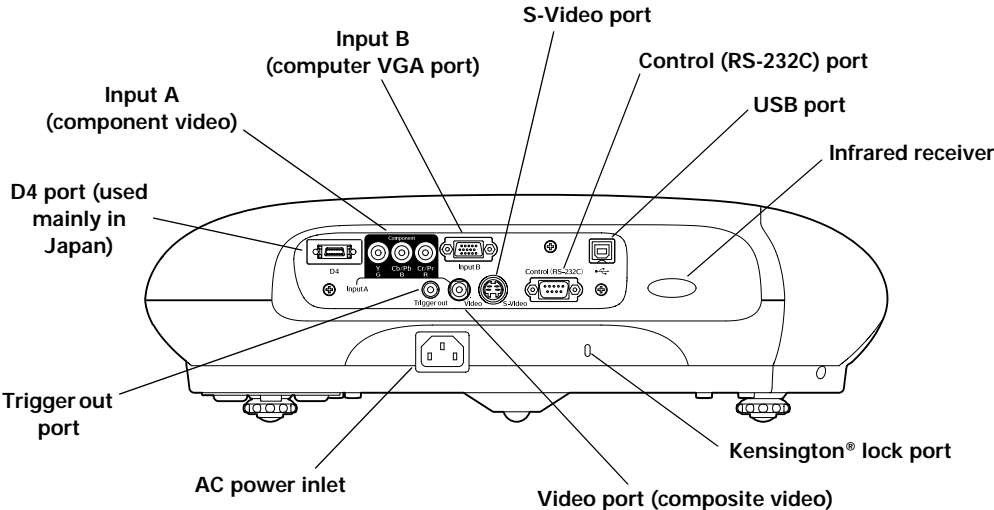
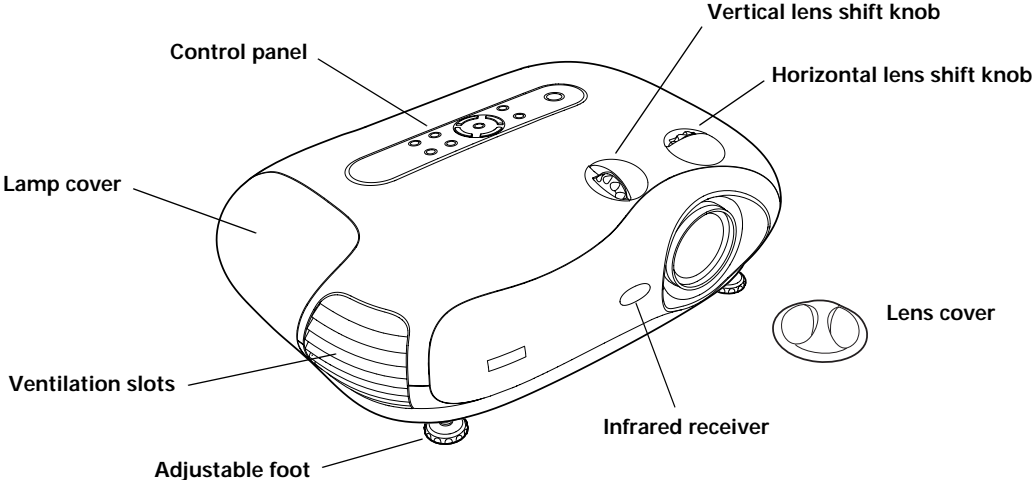

Projection Controls

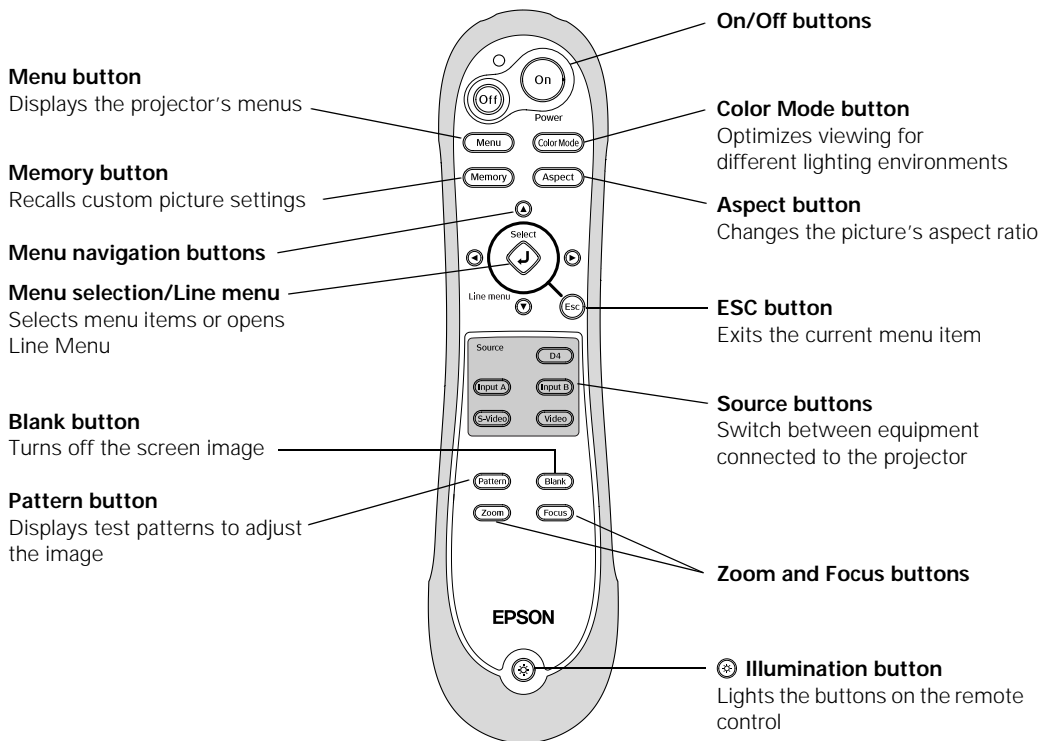
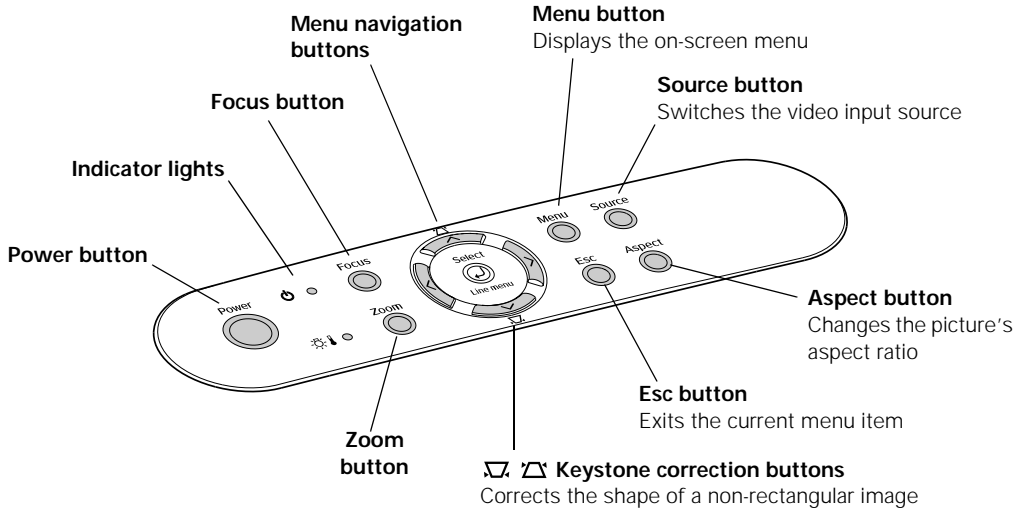

Optional Accessories

EPSON provides the following optional accessories for the projector:

Product	Part number
Replacement lamp (ELPLP28)	V13H010L28
Air filter replacement (ELPAF04)	V13H134A04
Ceiling mount	ELPHB01
Kensington security lock	ELPSL01
Projection screens: 50-inch portable screen 60-inch portable pop-up screen 80-inch portable pop-up screen	ELPSC06 ELPSC07 ELPSC08
Macintosh® adapter set (includes monitor adapter and desktop adapter)	ELPAP01
S-video cable	ELPSV01

You can purchase many of these accessories from your dealer, by calling EPSON at (800) 873-7766, or by visiting the EPSON StoreSM at www.epsonstore.com (U.S. sales only). In Canada, please call (800) 463-7766 for dealer referral.

Using This Manual

This book contains all the information you need to use the projector, in addition to basic setup and maintenance instructions, troubleshooting tips, important safety instructions, specifications, and warranty information.

Please follow these guidelines as you read through the manual:

Warnings: Must be followed carefully to avoid bodily injury.

Cautions: Must be observed to avoid damage to your equipment.

Notes: Contain important information about your projector.

Tips: Contain helpful projection tips.

Getting More Information

Need additional help? Take advantage of EPSON's automated support services 24 hours a day at <http://support.epson.com>. Use this site to download FAQs or product information and e-mail your questions to EPSON support.

If you need more help, you can use the EPSON PrivateLine® Support service. Call (800) 637-7661 and enter the PIN on the PrivateLine support card that came with your projector.

Setting Up the Projector

Follow the instructions in this section to choose a location for the projector, connect the cables, and display and adjust the image.

Choosing a Location

You can install the projector for various viewing setups, as shown below.

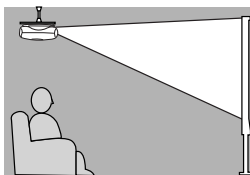

Front/Ceiling

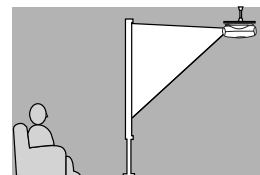

Rear/Ceiling

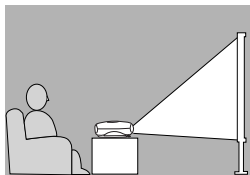

Front

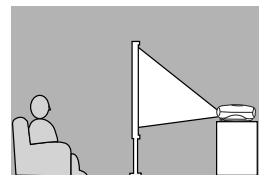

Rear

If you install the projector in a rear or overhead position, you'll need to flip and/or mirror the image by selecting the correct Projection option (see page 18). For overhead projection, you'll also need to install the optional ceiling mount bracket (see page 10 for ordering information).

For all setups, it's best to place the projector at a height where its lens is between the top and bottom of the screen. That way, you can keep the projector level and use the vertical lens shift knob to position the image. This produces the best-looking picture.

If you place the projector above or below screen level, you'll have to tilt it up or down to aim the image at the screen; this distorts the shape of the image, but you can correct its shape using the projector's Keystone function (see page 19).

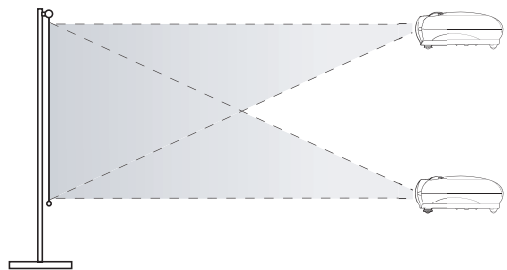

If you place the projector off to the side, aim it straight ahead (rather than at the center of the screen), then use the horizontal lens shift knob to center the image. Do not place the projector farther to the left or right than the edge of the screen, or you will not be able to project a square (or rectangular) image.

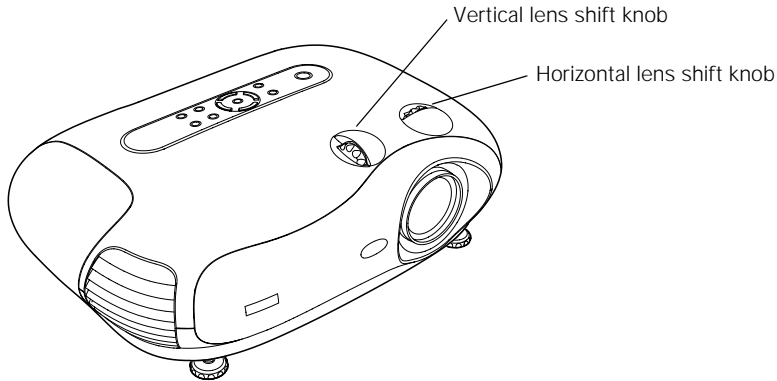

The maximum size of the image is determined by the distance from the projector's lens to the screen. Depending on how you use the Zoom and other settings, the actual size may be smaller. Use this table as a rough guide for projector placement:

Projection distance	Maximum image size (16:9)
2.9 feet	30 in. (26 × 14 in.)
3.9 feet	40 in. (34 × 19 in.)
5.9 feet	60 in. (52 × 29 in.)
7.9 feet	80 in. (69 × 39 in.)
9.9 feet	100 in. (87 × 49 in.)
19.9 feet	200 in. (174 × 98 in.)
29.9 feet	300 in. (261 × 147 in.)









Also keep these considerations in mind:

- Make sure there is plenty of space for ventilation around and under the projector. Do not set the projector on top of loose materials that could block the vents underneath.
- Make sure the projector is within 10 feet of a grounded electrical outlet or extension cord.

Connecting the Cables

You can connect the projector to any type of video equipment, such as a VCR, DVD player, HDTV tuner, cable or satellite box, video game console, camcorder, or digital camera. You can also connect it to a desktop or laptop PC or Apple® Macintosh system.

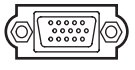
You can connect up to four pieces of equipment at the same time, as shown in this table:

Port name	Video equipment connection	Computer connection
Video 	Use a standard RCA video cable: 	—
S-Video 	Use a standard S-video cable: 	—
Input A (Component) 	Use a standard component video cable (with RCA-style connectors):  Select YCbCr, YPbPr, or RGB-Video as the Input Signal setting (see page 18).	—
Input B 	—	Use a standard VGA computer cable: 

Note: For details on compatible video formats, see page 65.

Connect your video or computer equipment to these ports:

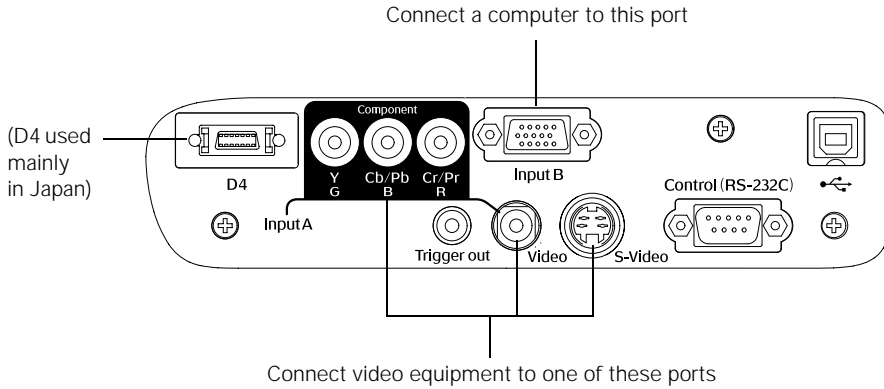

If you connect to the Input A port, be sure to select the correct Input Signal setting for your equipment, or the image may not display properly (see page 18).

Other Connections

■ Power cable

Plug the power cable into the projector and a grounded electrical outlet. The  power light on the projector's control panel turns orange when the projector is receiving power and is in standby mode.

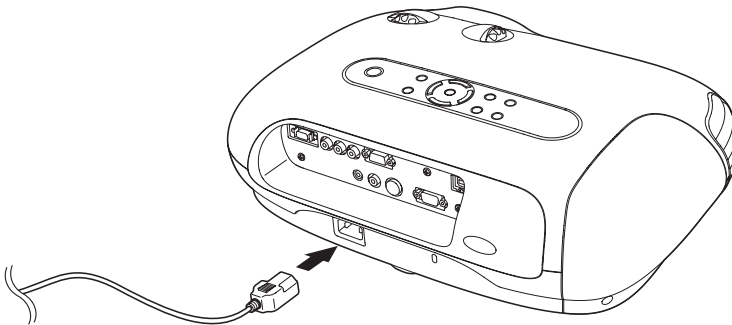

■ Control (RS-232C) and USB ports

Connect a computer to one of these ports to use the Cinema Color Editor software. See page 41 for details.

■ Trigger out port

This port outputs a 12-volt DC signal when the projector is turned on. This lets a central control system monitor whether the projector is on or off, and can be used to raise or lower your projection screen automatically when the projector is in use.

Connect to it using a 3.5-mm mini jack cable, as shown.

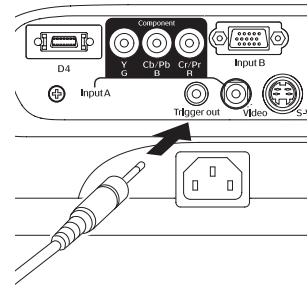

Displaying and Adjusting the Image

Make sure your video or computer equipment is turned on, then turn on the projector as described on page 21. If necessary, select the correct source to display the image (see page 22).

Note: If you turn on the connected equipment before starting the projector, the projector automatically detects and displays the image. If you turn on the projector first, or have multiple pieces of connected equipment, you may have to select the source manually.

If an image does not appear, check the troubleshooting tips on page 57.

Focusing and Zooming the Image

To adjust the sharpness or size of the image:

1. Press the Focus or Zoom button on the projector or remote control.

You see this screen:

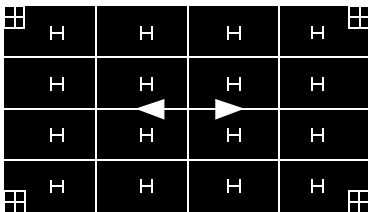

2. Use the ◀ arrow ▶ buttons to adjust the image.

Note: If you use the remote control, you can stand close to the screen while focusing the image. This lets you adjust the picture more precisely.

3. Press ESC when done.

Inverting and Mirroring the Image

If the image is displayed upside-down or backward, select the correct Projection option:

1. Press the Menu button on the remote control.
2. Use the menu navigation buttons to open the Setting menu, then open the Screen menu, and then select Projection.
3. Choose from these options:
 - Front if the projector is located in front of the screen (for example, on a table).
 - Front/Ceiling if the projector is located in front of the screen and mounted overhead.
 - Rear if the projector is located behind the screen.
 - Rear/Ceiling if the projector is located behind the screen and mounted overhead.

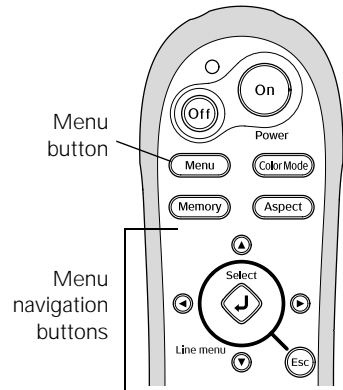

Selecting the Input Signal Setting

If you're using the projector's Input A port, select the correct setting for the type of video equipment you've connected to it:

1. Press the Menu button on the remote control.
2. Use the menu navigation buttons to open the Setting menu, then open the Input Signal menu, and then select Input A.
3. Choose from these options:
 - YCbCr for a video player that outputs an NTSC signal.
 - YPbPr for a video player that outputs an HDTV signal.
 - RGB-Video if your video player outputs an RGB video signal.

Note: Check the label next to the port on your video equipment, if you're unsure which setting to use.

Positioning the Image



If the image is not centered on the screen, use the horizontal and vertical lens shift knobs to adjust its position.

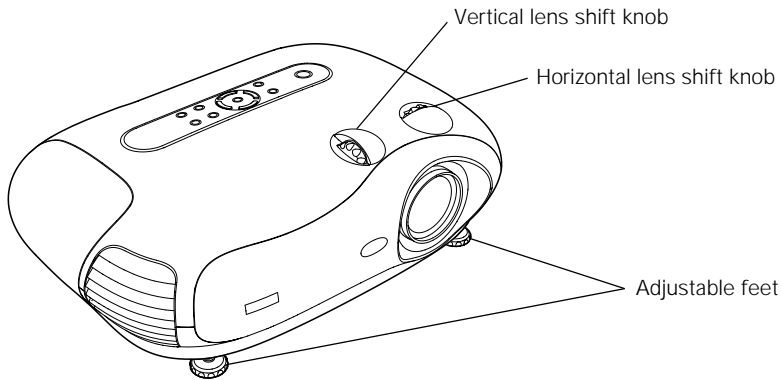

Note: You can display a test pattern to facilitate adjustment. Press the **Pattern** button on the remote control, then select **Cross-hatching**.



If you still need to raise the height of the image after using the vertical lens shift knob, lift the front of the projector and rotate the adjustable feet until the image is positioned correctly. You can also use the feet to correct the angle of the image if it's tilted.

Performing Keystone Correction

If the projected image looks like  or , use the Keystone function to correct its shape.

Note: If the image is shaped like  or , the projector has been placed off to the side of the screen and angled toward it. Face the projector straight ahead (instead of at the center of the screen), then use the horizontal lens shift knob to center the image.

To perform keystone correction:

1. Press the Menu button on the remote control.
2. Use the menu navigation buttons to open the Setting menu, then open the Screen menu, and then select Keystone.
3. Use the ◀ arrow ▶ buttons to adjust the shape of the image.
4. Press the Menu button when done.

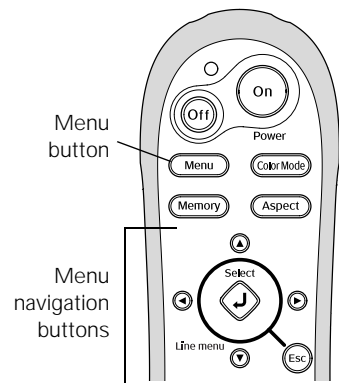

Basic Operation

Make sure the projector is set up as described on page 13, then follow the instructions below to turn it on and display an image.

Turning On the Projector

1. Remove the lens cap.

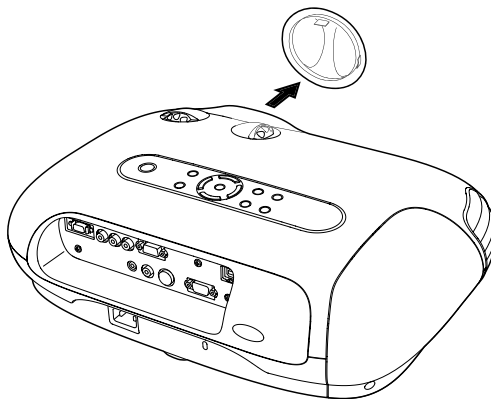

2. Press the On button on the remote control, or press the Power button on the projector.

Note: If this is your first time using the remote control, make sure batteries are installed as described on page 50.

To keep children from turning on the projector, you can use the projector's Child Lock (see page 25).

The projector takes about 30 seconds to warm up and display an image. If you don't see a picture, you may need to change the image source as described on the next page.

Turn on the projector

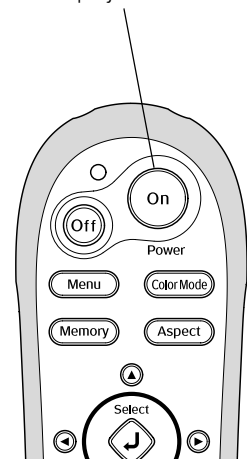

Turning the Projector Off

To turn off the projector, press the Off button on the remote control (or press the Power button on the projector twice).

Let the projector cool while the \odot power light flashes red (about 30 seconds). Once the light stops flashing and stays on, it's safe to unplug the projector.

Caution: Turn the projector off when not in use. Continuous 24-hour-a-day use may reduce its overall life. Never unplug the projector without pressing the Off button and letting it cool, or you could damage the projector and reduce lamp life.

Selecting the Image Source

The Source buttons let you switch between images output from different pieces of equipment connected to the projector (such as a DVD player, cable or satellite box, or video game console).

If you don't see the image you want, press the Source button that corresponds to the port to which your video source is connected.

For example:

To select the image source connected to the Video port . . .

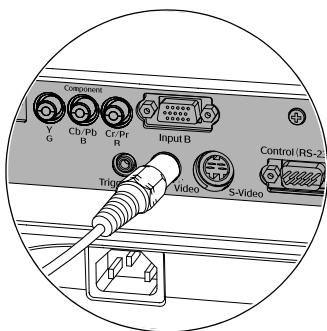

. . . press the Video button

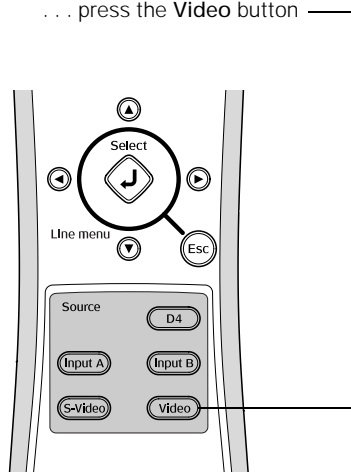

Note: If you're projecting in a darkened room, press the \odot button (located near the bottom of the remote control). This lights up all the keys.

To temporarily turn off the image and darken the screen (without turning off the projector), press the **Blank** button. Press the **Blank** button again to return to normal viewing.

Choosing the Aspect Ratio

Composite and S-video signals are sized automatically to fit on your screen when Auto is selected as the Aspect setting. If you're viewing a component video signal, you may need to change the size of the image (or aspect ratio) by pressing the Aspect button on the remote control.

- If your video source is connected to the projector's Video or S-Video port, select Auto to automatically display your image in the correct size.
- If the Auto option is unavailable (when the source is connected to the Input A or B port), you'll most likely want to choose one of these settings:

Normal for standard TV broadcasts, computer images, or images having a 4:3 aspect ratio.

Zoom for images recorded in 16:9 (wide-screen) format.

4:3 image using Normal setting



16:9 image using Zoom setting



On occasion, you may wish to select one of these options:

- Squeeze for DVDs or video recordings made in a compressed (or anamorphic) 16:9 format, sometimes called "Squeeze Mode."
- Through if your image is smaller than 1280×720 pixels and you want to display it at its original pixel size without resizing it to fit on the screen.
- Squeeze Through if your image is recorded in Squeeze Mode, is smaller than 1280×720 pixels, and you want to display it at its original pixel size.

Note: If you display a 4:3 image using the Zoom setting, the edges of the image will be cut off. You can use the Zoom Caption option to resize and reposition the image to your liking (see page 35).

For details on how the projector resizes the picture size when you choose an Aspect setting, see page 66.

Choosing the Color Mode

You can change the Color Mode to automatically adjust brightness, contrast, and color, letting you quickly optimize the projected image for various lighting environments. You can also select a different color mode for each input source—which is useful if you view different types of images from different sources. (For example, you might set the S-Video source to Living Room if it's usually used for watching movies, and then set the Video source to Dynamic for playing video games.)

Select the image source you want to adjust, then press the Color Mode button on the remote control. Choose from these settings:

- Dynamic for projecting in bright rooms; images retain their natural color.
- Living Room for projecting in rooms with subdued lighting; images retain their natural color.
- Natural for projecting in darkened rooms; increases contrast and makes flesh tones appear more natural.
- Theatre for projecting movies with dark scenes.
- sRGB for projecting computer images that conform to the sRGB color standard.

Note: You can fine-tune the color and other image quality settings using the projector's menu system (see page 29) or the Cinema Color Editor software (see page 39). You can also create your own customized groups of settings (see page 33).

Locking the Projector

The projector includes various Lock settings to prevent the image from being accidentally changed once it's adjusted, and to keep children from turning on the projector without adult supervision.

To access the Lock settings, follow these steps:

1. Press the Menu button on the remote control.
2. Use the menu navigation buttons to open the Setting menu, then open the Operation menu, and then select Lock Setting.
3. Choose from these options:
 - Focus Lock to prevent the focus from being changed.
 - Zoom Lock to prevent the picture size from being changed.
 - Child Lock to make it more difficult to turn on the projector from the control panel (but does not affect operation of the remote control).

To turn on the projector, either use the remote control, or press and hold the projector's Power button for at least 3 seconds.

- Key Lock to disable all the buttons on the projector's control panel.

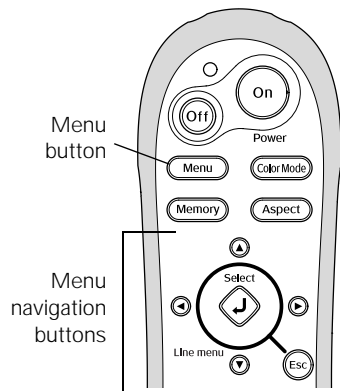

Making Adjustments

You can use the projector's on-screen menus to adjust the image quality, such as the brightness, contrast, sharpness, and color. You can also change how the menu display, sleep mode settings, and other projector features.

Using the Menu System

You can access the menu system either from the remote control or by using the buttons on the projector's control panel. With the menu system, you can adjust any of the settings described in this chapter. You can also change the menu language and choose from various options that control how the menus display (see page 28).

1. Press the Menu button on the projector or remote control.

You see a screen similar to this one (the actual screen depends on the equipment you've connected):

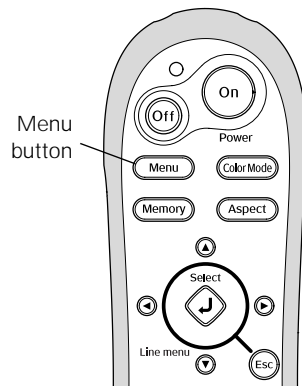
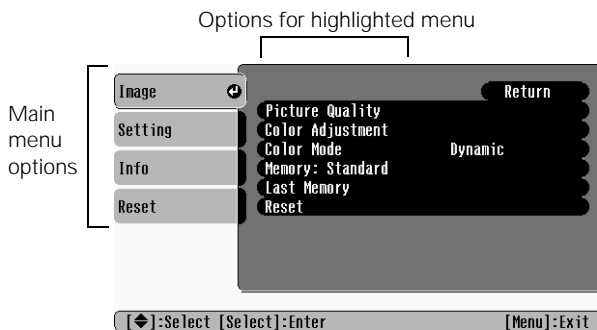

Note: If no equipment is connected to the projector, some options may not be available.

2. Use the arrow buttons to highlight the desired option, then press **↵** to select it.
3. Change any settings, as needed. (You may have to press **↵** to confirm your choice.)
4. When done, press the Esc button to return to the previous menu, or press the Menu button to exit.

Changing How the Menu Displays

Use these options to control how the menu displays on the screen.

■ Language

Setting → Language

Select from nine languages to use in the menu system.

■ Menu Position

Setting → On-Screen Display → Menu Position

Use the arrow buttons to choose a position on the screen for displaying the menu.

■ Navigation Bar

Setting → On-Screen Display → Navigation Bar

Select whether to display the navigation bar, which prompts you on which buttons to push to choose menu options.

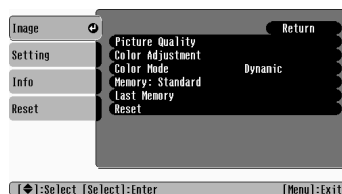

■ Menu Color

Setting → On-Screen Display → Menu Color

Select a color scheme for display the menus.

Adjusting the Image Quality

Before fine-tuning the image using these adjustments, make sure you have already selected the best Color Mode for your picture and viewing environment, as described on page 24. The Color Mode adjusts various settings to approximately correct levels, simplifying your adjustment of the picture.

Most image quality settings are saved independently for each input source (Video, S-Video, Input A, Input B). After you finish adjusting the settings for one input source, be sure to switch to each additional input source you'll be using and make any necessary adjustments.

Brightness and Contrast Settings

The Brightness setting controls how much light is produced by the projector lamp, and the other settings listed below control how the projector interprets the light and dark areas of the picture.

Adjust the Brightness first, then fine-tune the image with the other settings, as described.

■ Brightness

Image → Picture Quality → Brightness

Adjust the brightness so it's suitable for your viewing conditions. For example, if you're projecting in a brightly lit room or onto an especially large screen, you may need to increase the brightness. Decrease the brightness for dark rooms or small screens; this also reduces power consumption and fan noise, and helps to prolong the life of the lamp.

■ Setup Level

Setting → Advanced → Setup Level

For compatibility with most video equipment sold in the United States, set to 7.5%. This adjusts the threshold at which dark areas of the image are rendered black. Check your video equipment's specifications to be sure of the correct setting.

■ Input Level/Contrast

Image → Picture Quality → Input Adjustment → Input Level/Contrast

Adjust the Input Level to set the overall brightness of the image. Then adjust the contrast, as needed.

If you cannot access the Input Level and Contrast settings, highlight Input Adjustment (the first item in the menu list) and press the **↵** button, then choose Input Level/Contrast in the sub-menu.

■ White Level/Black Level

Image → Picture Quality → Input Adjustment → White Level/Black Level

Adjust the White Level so that details in the brightest parts of the image are not washed out. Then adjust the Black Level so that shadow-level details are still visible in the darkest parts of the image.

If you cannot access the White Level and Black Level settings, highlight Input Adjustment (the first item in the menu list) and press the **↵** button, then choose White Level/Black Level in the sub-menu.

Sharpness and Picture Quality Settings

If the image looks fuzzy, or if it contains noise or flickering, you can use these settings to correct it.

■ Sharpness

Image → Picture Quality → Sharpness

Use this function to make lines and edges appear more distinct in the image.

■ Progressive

Setting → Advanced → Progressive

Leave this setting off (in interlaced mode) when viewing images containing a lot of movement, such as videos and DVDs. If you notice horizontal lines or flickering when viewing still images (such as computer graphics or digital camera photos) or when pausing videos, turn the setting on to convert interlaced mode to progressive.

■ Noise Reduction

Setting → Advanced → Noise Reduction

Leave this setting off, unless viewing images from a weak signal with a lot of noise. Turning the setting on suppresses interference and makes images appear softer (available only if the image source is set to Video or S-Video).

Color Settings

If the image colors don't look correct, you can adjust them using these settings. Use the first three settings described below to make the most visible changes. If you only need to make slight adjustments, you can fine-tune the picture with the last two settings.

Note: You can also make color adjustments by attaching a PC or laptop to the projector and using the Cinema Color Editor software. See page 39.

■ Color Intensity

Image → Picture Quality → Color Intensity

Use this setting to adjust the color saturation of the image. (This setting is not available for computer images.)

■ Tint

Image → Picture Quality → Tint

Use this setting to shift the color balance between magenta and green. (This setting is not available for computer images.)

■ Color Temp.

Image → Color Adjustment → Color Temp. → Color Temp.

Use this setting to shift the color balance between red and blue.

Note: You can also access the Color Temp. setting by pressing the  button on the remote control to open an on-screen "line menu."

■ Flesh Tone

Image → Color Adjustment → Color Temp. → Flesh Tone

Use this setting to make fine adjustments to the tint. Controls the amount of magenta or green in the image. Also useful for correcting black-and-white images, if they look tinted.

Note: You can also access the Flesh Tone setting by pressing the  button on the remote control to open an on-screen "line menu."

■ RGB

Image → Color Adjustment → RGB

Use the RGB settings to fine-tune the color of the image. You can adjust the offset, gamma, and gain for each signal color (red, green, and blue). Use Offset to adjust darker shades, Gamma for intermediate shades, and Gain for the lightest shades.

Adjustments for Computer Images

In addition to the settings described above, you can adjust the Tracking and Sync settings for analog RGB computer images. Normally, these settings are adjusted automatically by the projector. If you notice that the image is blurry or contains dark vertical bands, you may need to adjust the settings yourself.

■ Auto Setup

Image → Auto Setup

Leave this setting on so that the projector automatically adjusts the tracking, sync, and position of the image.

■ Tracking

Image → Picture Quality → Tracking

Adjust the tracking to eliminate vertical bands. Easiest to adjust when the image contains a lot of fine detail (such as black text on a white background).

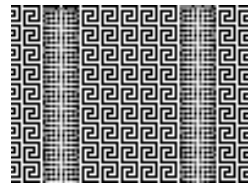

■ Sync.

Image → Picture Quality → Sync.

Adjust the synchronization to eliminate blurriness. For best results, make sure the tracking is properly adjusted first.

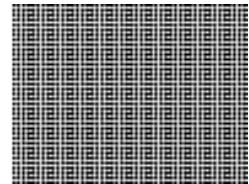

Saving and Resetting Menu Selections

Once you've adjusted the picture settings, you can save them as a group using the Memory feature. This lets you easily recall them, and switch from one group of settings to another. You can save up to six groups of settings.

If necessary, you can use the projector's reset options to restore its factory-default settings. You can clear all the settings, or just the settings in a specific menu.

Creating Memory Settings

After adjusting the picture to your liking, you can save your settings as a group in the projector's memory. This stores all the image quality settings described on pages 29 through 32, plus the Aspect and Color Mode settings (pages 23 and 24).

1. Press the Menu button on the remote control.
2. Open the Image menu, then select Memory: Standard.
3. Select the memory name you want to use, then press the  button. Your settings are saved.

Note: Saved settings are indicated by a green  highlight next to the memory name. If you select a name that is already in use, the existing contents will be erased and the new settings saved in their place. You can use Cinema Color Editor to customize the names of the settings (see page 48).

Once you have created one or more memory settings, you can easily recall them:

1. Press the Memory button on the remote control.
2. If you've used Cinema Color Editor to create advanced memory settings, choose Standard or Advance to select the type of setting you want to use.
3. Use the arrow buttons to select the desired setting, then press the .

Note: The Last Memory option is available only if you've created advanced memory settings using Cinema Color Editor. Select **Last Memory** if you want to return to the last standard memory setting that was used.

After a moment, the image appears on the screen using your selected setting.

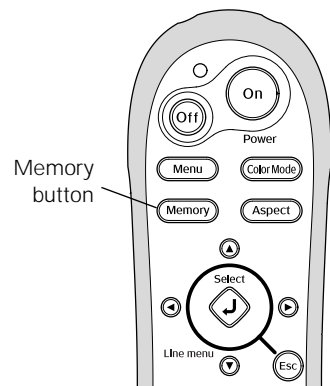

Resetting the Projector

If the image quality isn't what you expect, one or more settings may be adjusted improperly. If necessary, you can restore the projector to its factory-default (original) settings.

To restore the settings in a specific menu (such as the Image or Setting menu), open that menu, select Reset, and confirm as needed. The example below shows how to reset the Image menu:

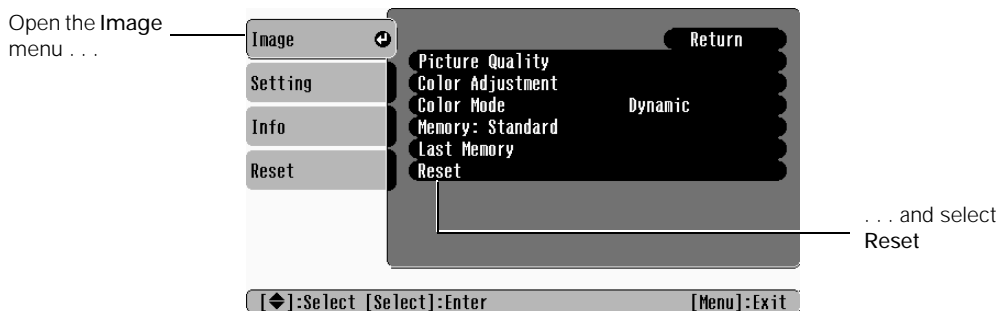

You can also reset the lamp usage timer, clear the memory settings, or restore all the projector settings to their original values. Follow these steps:

1. Press the Menu button on the remote control.
2. Open the Reset menu.
3. Do one of the following:
 - Select Lamp-Hours Reset to clear the lamp usage timer and reset it to zero (see page 53 for more information).
 - Select Memory Reset to clear any memory settings you created as described on page 33.
 - Select All Reset to return all projector menus to their original settings.

Note: All Reset does not reset the lamp timer, menu language, Input Signal, and memory settings.

Customizing Projector Features

Use the settings in this section to adjust the image size and position, suppress on-screen text, and select basic setup options.

Image Sizing

Before adjusting any of these settings, make sure you have already selected an appropriate aspect ratio for the type of picture you're viewing (see page 23).

■ Output Scaling

Setting → Advanced → Output Scaling

For standard video formats, this setting lets you see the edges of the image that are not normally visible in the picture. Select **Larger** to view component video and RGB video at 100% size; composite video and S-video formats are shown at 95%. (Normal displays images at 92% size.)

For analog-RGB computer signals, select **Smaller** to show a slightly reduced image if you see interference at the top or bottom of the screen. (Normal displays images at 100%.)

■ Position

Setting → Screen → Position

Use the arrow buttons to fine-tune the position of the image on the screen.

■ Zoom Caption

Setting → Screen → Zoom Caption

Lets you adjust the shape and position of the image so that subtitles are visible (available only if the aspect ratio has been set to **Zoom**). Use **Vertical Size** to adjust the proportions of the image, and **Zoom Position** to move the image up or down.

Screen Options

■ Message

Setting → On-Screen Display → Message

Turn this setting off if you want to prevent on-screen messages from appearing (such as the no-signal message, or the identifying text that appears when you switch between image sources or color modes).

■ Background Color

Setting → On-Screen Display → Background Color

Changes the screen that's used when the projector is not receiving a signal or when you press the Blank button to temporarily stop projection. Select Blue (instead of Black) or Logo to display the EPSON logo on a black background.

■ Startup Screen

Setting → On-Screen Display → Startup Screen

Turn this setting off if you want to prevent the EPSON logo from appearing while the projector is warming up.

Other Setup Options

■ Keystone

Setting → Screen → Zoom Caption

Adjusts the shape of the image, if the left and right sides are not parallel after tilting the projector up or down at the screen (see page 19).

■ Projection

Setting → Screen → Projection

Mirrors and/or inverts the image for front, rear, and overhead projection.

■ Input Signal

Setting → Input Signal

Adjust these settings for the type of equipment connected to the projector:

Video Signal: Leave this setting on Auto so the projector can automatically interpret the picture (only affects images displayed through the Video or S-Video port).

Input A: Change this setting to match the type of equipment connected to the Input A port. If necessary, check the label on your equipment to match the setting.

D4: Change this setting to match the type of equipment connected to the D4 port (used mainly in Japan).

■ COM Port

Setting → Operation → COM Port

Select the type of cable you've connected to your PC or laptop for running the Cinema Color Editor software. Choose USB or RS-232C (for a serial cable).

■ Trigger Out

Setting → Operation → Trigger Out

Turn on this setting if you want the Trigger out port to output a 12-volt signal while the projector is operating. You can use this to raise or lower your projection screen automatically.

■ Sleep Mode

Setting → Operation → Sleep Mode

Turn off this setting if you don't want the projector to enter sleep mode. (Sleep mode shuts the projector off automatically after 30 minutes when there is no video signal.) Leave the setting on to conserve power and extend the life of the lamp.

■ Lock Setting

Setting → Operation → Lock Setting

Lets you lock the projector's focus and zoom settings. Also lets you lock the buttons on the projector's control panel, or set a child lock that makes it more difficult to turn on the projector. See page 25.

Using Cinema Color Editor

You can use the Cinema Color Editor software that came with your projector to adjust each color in the picture individually. You can also use the software to operate the projector in place of your remote control, letting you switch image sources, adjust the picture's aspect ratio, or change image quality settings. Once you've adjusted the picture to your liking, you can save your settings so you can easily recall them for future use.

Setting Up Your Computer

Before using Cinema Color Editor, follow the instructions in this section to install the software and connect the projector to your computer.

System Requirements

You can install Cinema Color Editor on any Windows® or Macintosh system that meets these minimum requirements:

Windows	Macintosh
Microsoft® Windows 98 SE, 2000, NT® 4.0, Me, or XP	Macintosh OS 8.6 through 9.x, OS X 10.1.5 or later
Pentium® MMX™, 166 MHz or better	Power Macintosh G3, 300 MHz or better
10MB RAM, 2MB hard disk space	7MB RAM, 5MB hard disk space
XGA (1024 × 768) or better display adapter and monitor	

Installing the Software

Follow these steps to install the software:

1. Insert the Cinema Color Editor CD-ROM in your computer.
2. Turn off any anti-virus software that may be running, then click Continue.
3. Read the license agreement and click Agree.

You see this screen:

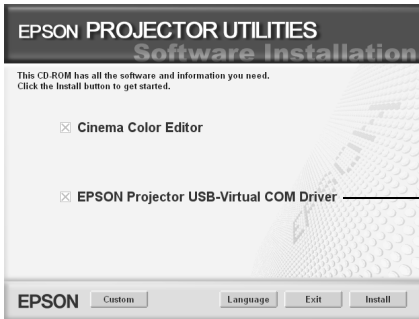

Not shown for Macintosh

4. Click Install and follow the on-screen instructions to perform the installation.

Caution: If you will be using a USB cable to connect to your computer, be sure to let the USB driver install as part of the installation sequence.

5. At the last screen, click Exit.
6. Restart your computer if prompted (Macintosh only).



Connecting to the Computer

Follow these steps to connect to your computer:

1. Connect the projector to your computer using either a USB cable (included with your projector) or an RS-232C (serial) cable.

Note: You can use any standard (commercially available) USB or serial cable.

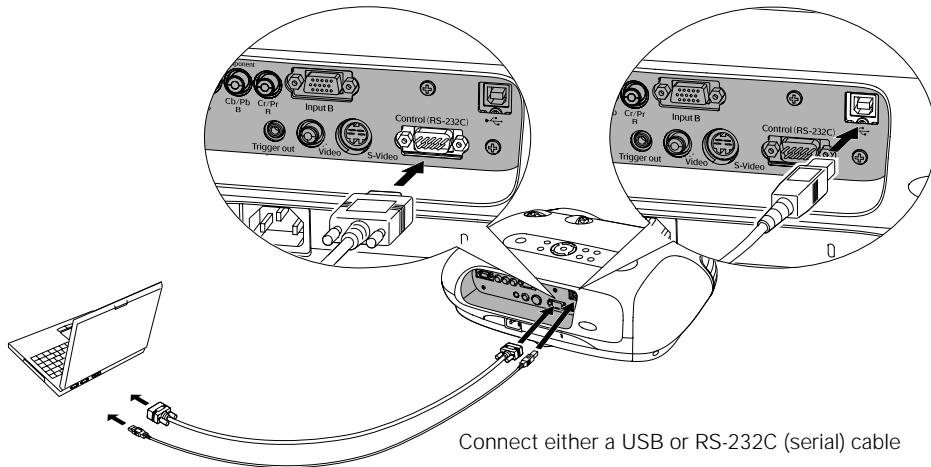

2. Turn on the projector.
3. Make sure the projector's COM Port setting is correct for the type of cable you're using (see page 37). Select either USB (if you're using a USB cable) or RS-232C (for a serial cable).
4. **Windows:** If you see a Found New Hardware or Add New Hardware screen, follow the instructions on the screen to finish installing the EPSON USB driver.

Caution: Make sure you have already installed all the software from the CD-ROM. If not, click Cancel and follow the instructions on page 40 first.

If you see a screen saying that the software has not passed Windows Logo testing, click Continue anyway.

Using Cinema Color Editor

To start Cinema Color Editor, follow these steps:

1. Make sure the projector is connected and turned on, as described on the previous page.
2. **Windows:** Click Start, Programs, EPSON Projector, and then Cinema Color Editor.

Macintosh: From the Applications folder on your hard drive, open the CCEditor folder and double-click Cinema Color Editor.

You see this screen:

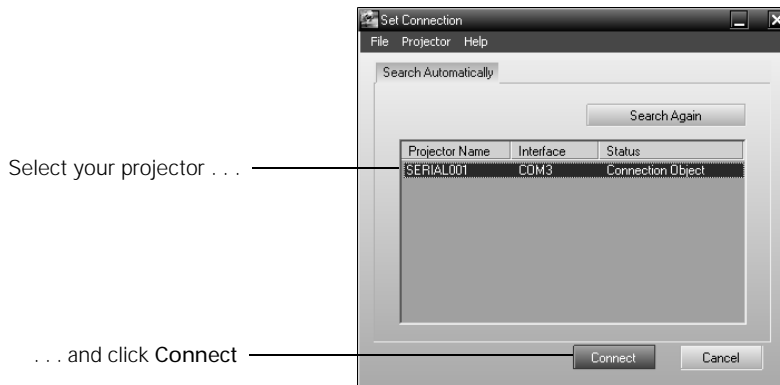

3. Select the name of the projector you want to adjust, then click Connect. You see this screen:

Now you can control the projector and adjust its settings as described on the following pages.

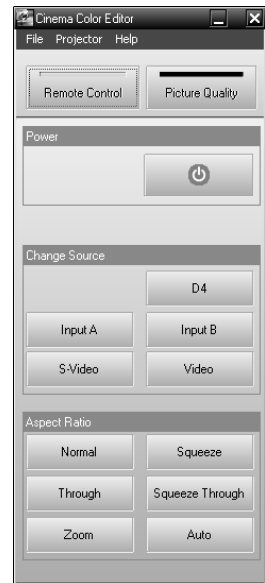

Remote Control Operations

You can use Cinema Color Editor to change the image source, adjust the aspect ratio, or turn the power off—just as you would from the remote control.

1. Click the Remote Control tab.

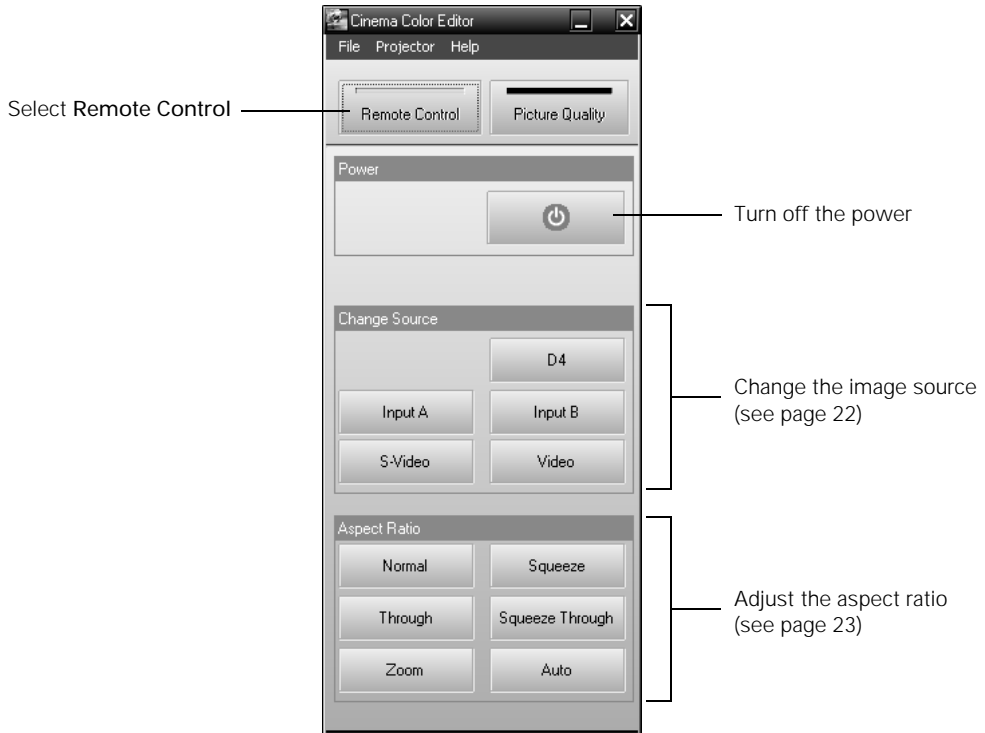

2. Click one of the buttons for the options shown above.

Adjusting the Picture Quality

You can use Cinema Color Editor in place of the projector's menu system to adjust the image.

1. Click the Picture Quality tab.

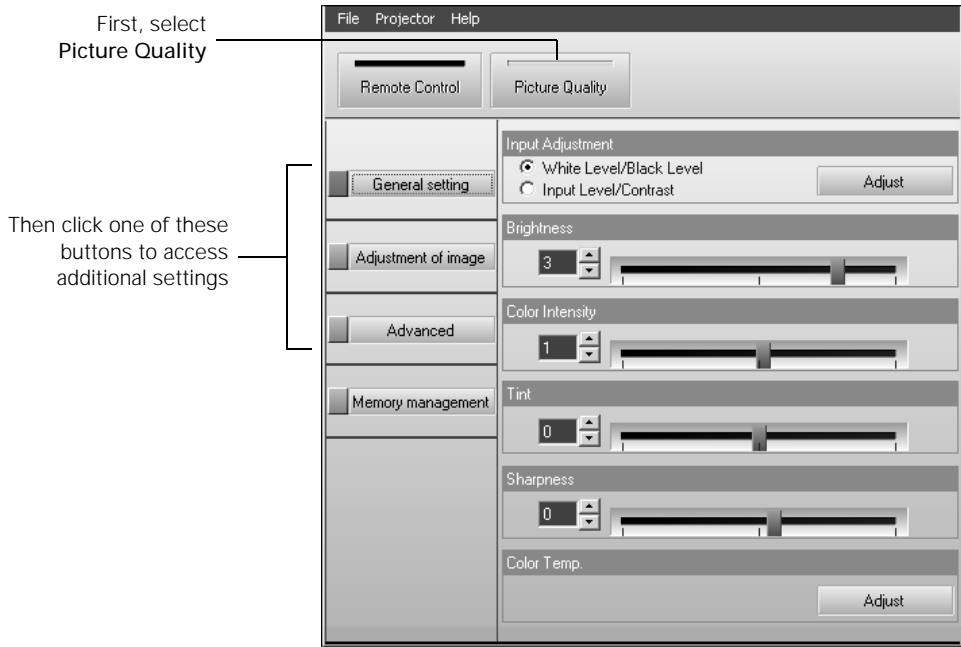

2. Click one of the buttons shown above to access additional settings. See the referenced page number below for details on using each setting:

Button	Available adjustments	Page reference
General setting	Input Adjustment Brightness Color Intensity Tint Sharpness Color Temp. and Flesh Tone	pages 29 and 30 page 29 page 31 page 31 page 30 page 31
Adjustment of image	Color Mode Color Adjustment	page 24 page 45
Advanced	Progressive Output Scaling Setup Level	page 30 page 35 page 29

Adjusting the Color

You can use the Color Adjustment settings to fine-tune the color of the image. If you select RGB as the color mode, you can adjust the offset, gamma, and gain for each signal color (red, green, and blue). Or select RGBCMY to adjust the hue and saturation for each of six colors.

1. Select Picture Quality, then click Adjustment of image.

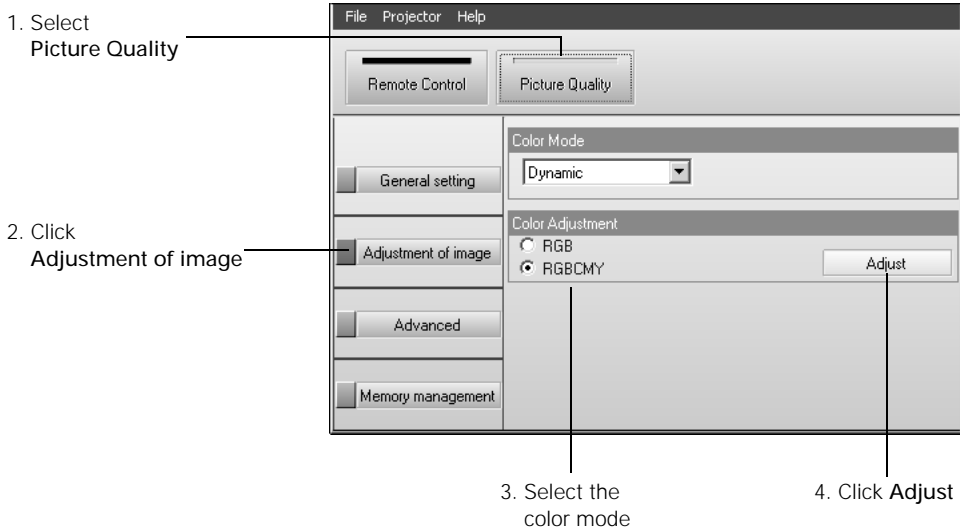

2. Select one of the following color modes, then click Adjust.

- **RGB:** Lets you adjust the offset, gamma, and gain for each signal color. Use Offset to adjust darker shades, Gamma for intermediate shades, and Gain for the lightest shades.
- **RGBCMY:** Lets you adjust the hue and saturation for each of six colors, as shown on the color palette below. After moving a slider bar, click Apply.

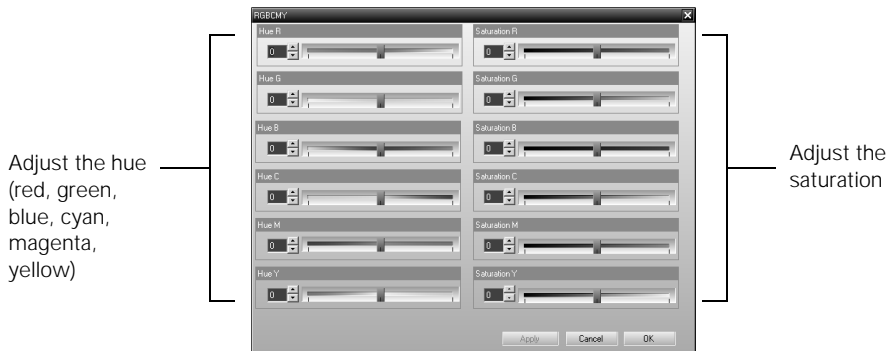

Saving and Recalling Picture Settings

Once you've adjusted the picture using Cinema Color Editor, you can save your settings in the projector's memory. Then you can use the remote control (or Cinema Color Editor) to easily recall them for future use.

To save your settings on the projector:

1. Select Picture Quality, then click Memory management and choose Register.

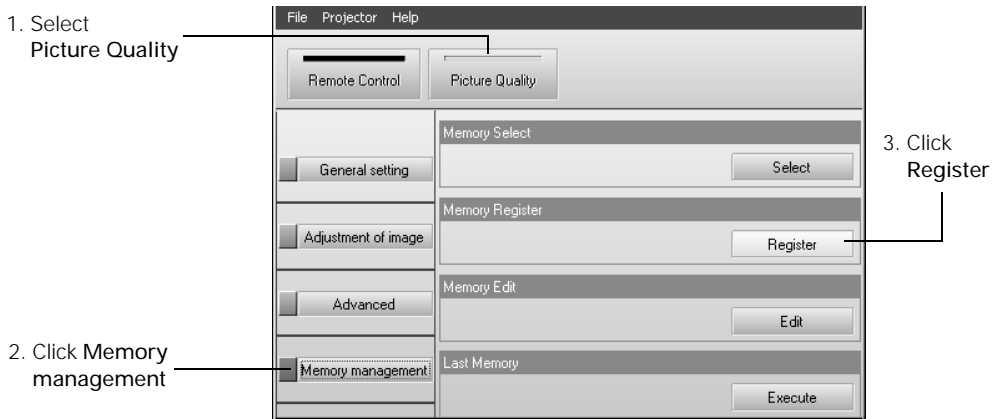

2. On the next screen, click the Advance tab to save your settings if you've made changes to the picture using the RGCMBY adjustments. Otherwise, click Standard.

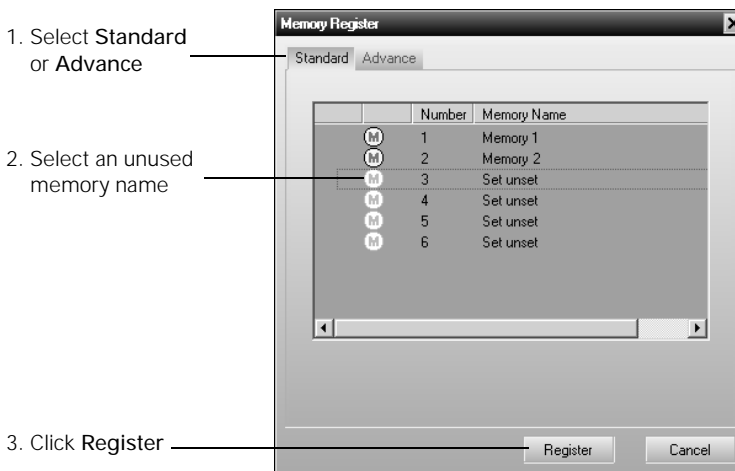

3. Select an unused memory name, then click Register. Your current settings are saved to the projector's memory.

To use a memory setting you've saved on the projector:

Access the projector's memory settings either from the remote control (see page 33) or by using Cinema Color Editor as follows:

1. Select Picture Quality, then click Memory management and choose Select.



2. Click the tab where the setting you want to use is stored (Standard or Advance).

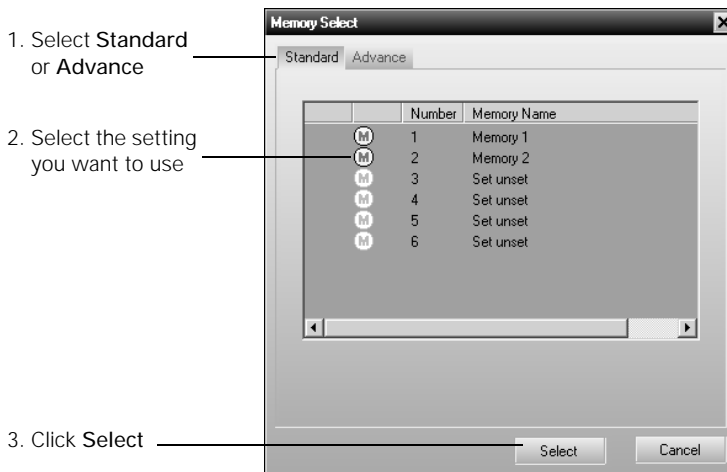

3. Select the desired memory setting, then click Select. After a moment, your image appears on the screen using the selected setting.

Managing Your Settings

In addition to your projector's twelve memory settings (six standard and six advanced), you can store any number of settings on your computer's hard drive. You can also use Cinema Color Editor to rename or delete memory settings stored on your projector.

To save or recall settings on your computer:

In Cinema Color Editor, open the File menu, then choose one of the following:

- Save setting to store the current Cinema Color Editor settings on your computer's hard drive.
- Set from file to adjust the picture from settings previously saved on your hard drive.

Note: You can also transfer settings directly between the projector's memory and your computer's hard drive using the File Read and Save In File buttons (shown in the figure below).

To rename a memory setting stored on the projector:

1. Select Picture Quality, then click Memory management and choose Edit.
2. Click the tab where your setting is stored (Standard or Advance), select the setting whose name you want to change, then click Memory Name Change.

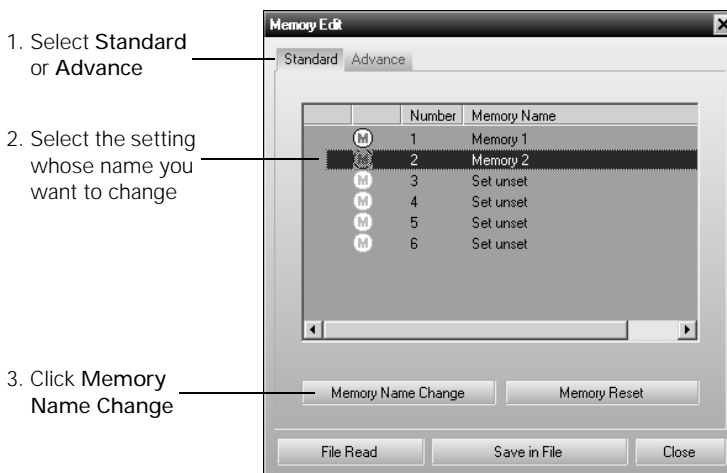

3. Type a name up to 12 characters long, then click OK.

To clear a memory setting stored on the projector:

1. Select Picture Quality, then click Memory management and choose Edit.
2. Select the setting you want to delete, then click Memory Reset and confirm the deletion.

Maintenance

Your projector needs little maintenance. All you need to do on a regular basis is keep the lens clean. You also need to clean the air filter periodically to prevent overheating.

Warning: Before you clean any part of the projector, turn it off and unplug the power cord. Never open any cover on the projector, except the lamp and filter covers. Dangerous electrical voltages in the projector can injure you severely. Do not try to service this product yourself, except as specifically explained in this *User's Guide*.

The only parts you should replace are the lamp and air filter. If another part needs replacing, contact your dealer or a qualified servicer.

Cleaning the Lens

Clean the lens whenever you notice dirt or dust on the surface.

- Use a canister of compressed air to remove dust.
- To remove dirt or smears, use lens-cleaning paper. If necessary, moisten a soft cloth with lens cleaner and gently wipe the lens surface.

Caution: Never rub the lens with abrasive materials.

Cleaning the Projector Case

Before you clean the case, turn off the projector and unplug the power cord.

- To remove dirt or dust, wipe the case with a soft, dry, lint-free cloth.
- To remove stubborn dirt or stains, moisten a soft cloth with water and a neutral detergent. Then wipe the case.

Caution: Never use wax, alcohol, benzene, thinner, or other chemical detergents. These can damage the case.

Changing the Remote Control's Batteries

The remote control uses two AA batteries. If you suspect they are weak, take the remote control to a darkened room and press the ☼ illumination button. If the buttons on the remote control do not glow red, replace the batteries as described below.

Warning: Keep batteries away from children. If a battery should be swallowed, contact your doctor immediately.

1. Release the tab and lift open the cover.

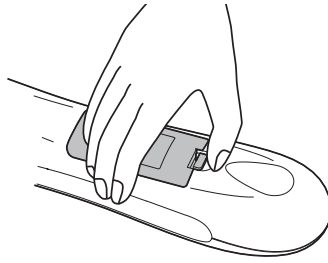

2. Remove the old batteries and insert the new AA batteries as shown.

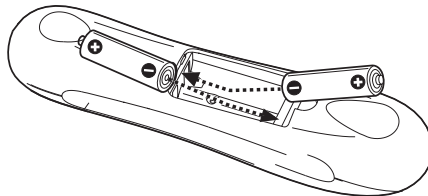

3. Replace the cover.

Cleaning and Replacing the Air Filter

Clean the air filter on the bottom of the projector after every 100 hours of use. If it's not cleaned periodically, it can become clogged with dust, preventing proper ventilation. This can cause overheating and damage the projector.

1. Turn off the projector and wait for the \odot power light to stop flashing.
2. Unplug the power cord and disconnect any cables.
3. Turn the projector over. Then use a small vacuum cleaner designed for computers and other office equipment to clean the filter, as shown. If you don't have one, gently clean the filter using a very soft brush (such as a clean artist's paintbrush).

If the dirt is difficult to remove or the filter is broken, replace it. Contact your dealer or call EPSON at (800) 873-7766 and ask for part number V13H134A04. In Canada, call (800) 463-7766 for dealer referral.

4. If you need to replace the filter, release the tab and lift the cover up.
5. Remove the old filter and replace it with a new one.

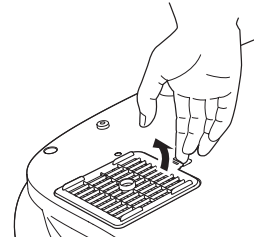
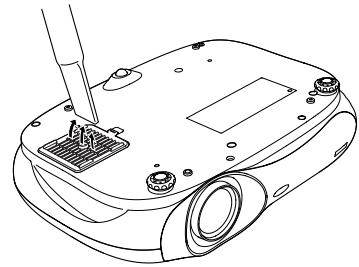
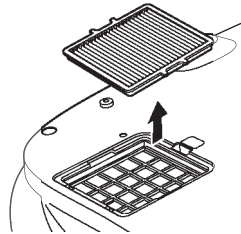

6. To replace the cover, insert the tabs and press down until the cover clicks into place.

Replacing the Lamp

The projection lamp lasts for up to 1700 hours (in low brightness mode) or 3000 hours (in high brightness mode). You can use the Info menu to check how long it's been in use (see page 56). It's time to replace the lamp when:

- The projected image gets darker or starts to deteriorate.
- The projector's warning light flashes red at half-second intervals.
- The message **Replace the lamp** appears on the screen when you start projecting.

Note: Lamp life results will vary depending on mode selected, environmental conditions, and usage.

Contact your dealer or call EPSON at (800) 873-7766 in the United States for a replacement lamp. Request part number V13H010L28. In Canada, call (800) 463-7766 for dealer referral.

Be sure to read the "Important Safety Information" on page 69 before replacing the lamp.

Warning: Let the lamp cool fully before replacing it. In the unlikely event that the lamp has broken, small glass fragments may be present and should be removed carefully to avoid injury.

The lamp component contains mercury. Please consult your state and local regulations regarding proper disposal or recycling, and do not place in the trash.

Caution: Never touch the lamp with your bare hands; the invisible residue left by the oil on your hands may shorten the lamp life. Use a cloth or glove to handle the new lamp.

Follow these steps to replace the lamp:

1. Turn off the projector and wait for the  power light to stop flashing.
2. Unplug the power cord and any cables.
3. If the projector has been on, let it cool for about an hour.
4. Loosen the two screws securing the lamp cover (they don't come all the way out), and then remove the cover.

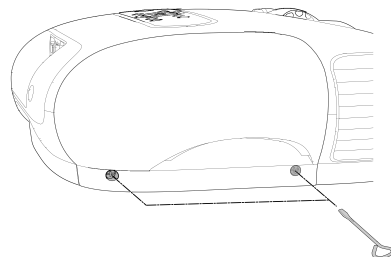
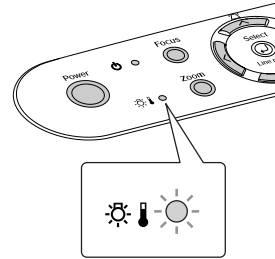

5. Loosen the two screws securing the lamp.

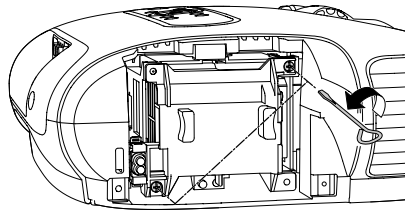

6. Grasp the lamp as shown and pull it straight out.

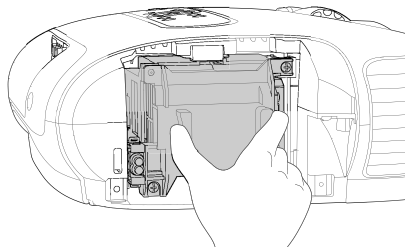

7. Gently insert the new lamp and tighten its screws.

Caution: Don't touch the glass portion of the lamp assembly. Touching the glass could result in premature lamp failure.

8. Replace the cover and tighten its screws. (The projector won't work if the lamp cover is open or loose.)
9. Reset the lamp usage timer, as described in the next section.

Resetting the Lamp Usage Timer

After replacing the lamp, follow these steps to reset the lamp usage timer:

1. Press the Menu button on the projector or remote control.
2. Use the menu navigation buttons to open the Reset menu, then select Lamp-Hours Reset.
3. When you see a confirmation prompt, highlight Yes and press the **↵** button.
4. When you're finished, press the Menu button to exit.

The lamp usage timer doesn't register until you've used the lamp for at least 10 hours.

Storing the Projector

If you need to store the projector for an extended time, do the following:

- Make sure the temperature and humidity of the storage area are within the recommended range for the projector (14 to 140 °F [-10 to 60 °C] and 10 to 90% relative humidity).
- Attach the lens cover and retract the feet.
- Remove the batteries from the remote control.
- Pack the projector in its original packaging or equivalent.

Transporting the Projector

Note: EPSON shall not be liable for any damages incurred during transportation.

The projector contains many glass and precision parts. If you need to transport it, follow these guidelines to prevent damage:

- When shipping the projector for repairs, use the original packaging material if possible. If you do not have the original packaging, use equivalent materials. Be sure the carrier is capable of transporting fragile equipment and is aware that the projector is fragile.
- When you are hand-carrying the projector, grip the recessed handles on the sides.

Problem Solving

This section explains how to interpret the projector's status lights, solve problems with the picture and remote control, and contact technical support.

What To Do When the Lights Flash

The lights on top of the projector indicate the projector's status and let you know when a problem occurs.

If the projector isn't working correctly, first turn it off, let it cool, and unplug it. Then plug the power cord back in and turn on the projector. If this doesn't solve the problem, check the status lights on top of the projector.

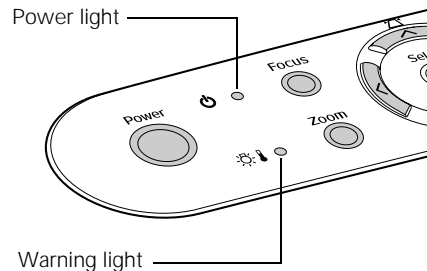

The power light is orange.

The projector is in standby mode. Unplug it or press the Power button to turn it on.

The power light is flashing green.

The projector is warming up. Wait for the picture to appear.

The power light is flashing orange and you can't turn on the projector.

The lamp is cooling down. Wait until the light stops flashing, then press the Power button.

The power light does not come on.

Make sure the power cord is connected securely both at the power outlet and the projector.

The  warning light is flashing orange.

High-speed cooling is in progress. If the projector gets too hot again, projection stops automatically. Make sure there is plenty of space around and under the projector for ventilation. Clean or replace the air filter if necessary (see page 51).

The  warning light is red.

The projector is too hot, which turns off the lamp automatically. Let it cool for five minutes, then turn it back on. Make sure there is plenty of space around and under the projector for ventilation. Also, clean or replace the filter if necessary (see page 51).

The  warning light is flashing red at one-second intervals.

- The lamp cover may be loose or off. Make sure it's securely fastened (see page 52).
- There is an internal problem. Turn off the projector and, when the  power light stops flashing, unplug it. Contact your dealer.

The  warning light is flashing red at half-second intervals.

The lamp needs to be replaced (see page 52).

Checking the Projector Status

You can use the Info menu to view information about the current display settings and how long the projection lamp has been in use. To access the Info menu:

1. Press the Menu button on the projector or remote control.
2. Use the menu navigation buttons to open the Info menu. The following information appears:
 - Lamp Hours
 - Source
 - Input Signal
 - Resolution
 - Video Signal
 - Refresh Rate
 - Sync Info



Note: The information displayed depends on the currently selected image source. The Lamp Hours shows 0H until you've used the lamp for at least 10 hours.

Solving Picture Problems

You cannot turn on the projector.

- Make sure the power cord is connected, then wait a moment for the  power light to turn orange before pressing the Power button.
- If you've set the Key Lock, the control panel buttons are disabled; you must use the remote control to turn on the projector (see page 25).
- If you've set the Child Lock, use the remote control or press and hold the Power button on the projector for at least 3 seconds to turn it on (see page 25).

No picture appears on the screen or you see the message No Signal displayed.

- Press the Source button on the projector or one of the Source buttons on the remote control to select the correct input source. Allow a few seconds for the projector to sync up after pressing the button.
- Press the Blank button on the remote control to make sure the picture hasn't been turned off temporarily.
- Check that the  power light is green, not flashing, and the lens cover is off.
- The projector may be in standby (or sleep) mode. If the  power light is orange, press the Power button to turn the projector back on.
- Make sure your video equipment is turned on.
- Make sure your cable(s) are connected correctly (see page 15).

You're using a computer and no picture appears on the screen.

If you're using a PC:

- Press the function key that lets you display on an external monitor. It's often labeled with an icon such as , but it may also be labeled CRT/LCD. You may have to hold down the Fn key while pressing it. Check your laptop's manual or online help.

On most systems, the  key lets you toggle between the LCD screen and the projector, or display on both at the same time. Allow a few seconds for the projector to sync up after pressing it.

- If the function key doesn't let you display simultaneously on both screens, you might need to use the Display utility in the Control Panel to make sure that both the LCD screen and external monitor port are enabled. From the Control Panel, open the Display

utility. In the Display Properties dialog box, click the Settings tab, then click Advanced. The method for adjusting the setting varies from computer to computer; you may need to click a Monitor tab, then make sure the external Monitor port is set as your primary display or enabled. See your computer manual or online help for details.

If you're using a Macintosh with OS X:

1. Select System Preferences from the Apple menu and click Displays.
2. Click Detect Displays.
3. To display the entire desktop on both your projector screen and LCD screen, click the Arrange tab. (If you don't see this tab, make sure it isn't hidden by another window.)
4. Click Mirror Displays in the lower corner of the screen. One of the monitor icons automatically moves on top of the other.

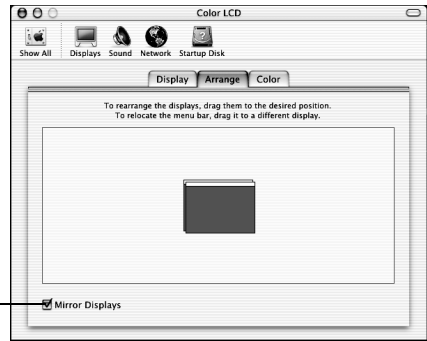

Click here

If you're using a Macintosh with OS 9.x or earlier:

1. From the Apple menu, select Control Panels, then click Monitors and Sound.
2. Click the Arrange icon, and then drag one monitor icon on top of the other.

If the Arrange option isn't available, you may need to select one of the Simulscan resolutions. Click the Monitor icon and then select a Simulscan resolution from the Resolution box. (Allow a few seconds for the projector to sync up.)

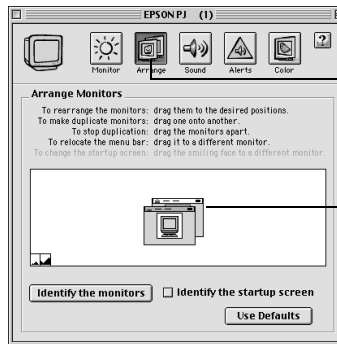

Click here

Drag one monitor icon on top of the other







The picture is upside-down or reversed.

Change the Projection setting in the menu system (see page 36).

Only part of the picture is displayed, or the picture is distorted.

- Press the Aspect button to select a different aspect ratio (see page 23).
- If the Aspect is set to Zoom, you may need to use the Zoom Caption option to see the top or bottom section of the screen (so that subtitles are visible). See page 35.
- Check the Output Scaling to make sure it's adjusted correctly (see page 35).
- Use the Position setting to reposition the image on the screen (see page 35).
- If you've connected a computer and you see only half the image, make sure the computer's Dual Display setting is turned off.

The picture isn't rectangular.

- If the image looks like  or , the projector has been placed off to one side of the screen and angled toward it. Face the projector straight ahead (instead of at the center of the screen), then use the horizontal lens shift knob to center the image (see page 19).
- If the image looks like  or , use the remote control to access the Keystone function to correct its shape (see page 19). Or press the  and  buttons on the projector's control panel.

Note: You won't have to use the Keystone function to correct the image, as long as you place the projector level (not angled up or down) and at a height between the top and bottom of the screen. Then use the vertical lens shift knob to position the image. This produces the best-looking picture.

The picture contains static or noise.

- Make sure the Input Signal is set correctly for your connected video equipment (see page 37).
- If you're viewing still images and you notice flickering or horizontal lines, turn on the Progressive setting (see page 30).
- Make sure your cables are securely connected at both ends.
- If you're using an extension cable, you may pick up interference unless you use a signal amplifier. Or try turning on Noise Reduction (see page 30).
- If you're displaying the same image on your computer and projector screen, try turning off your laptop's LCD display.

The picture is blurry.

- Make sure the Input Signal is set correctly for your video equipment (see page 37).
- There may be dirt on the lens. Clean the lens as described on page 49.
- Adjust the focus (see page 17).
- Make sure the lens is not fogged by condensation. If you've just moved the projector from a cold environment, wait a couple of minutes before using it.
- Adjust the Sharpness setting (see page 30).
- If you're projecting from a computer, you may need to adjust the Tracking and Sync settings (see page 32).

The colors on the screen don't look right.

- Make sure the Input Signal is set correctly for your connected video equipment (see page 37).
- Press the Color Mode button on the remote control to select a different color mode.
- Check the brightness and contrast settings described on page 29.
- Fine-tune the colors with the settings listed on page 31. You can also use Cinema Color Editor to adjust each color individually (see page 39).
- If the picture looks dark, you may need to replace the lamp. Check the lamp usage timer to see how long the lamp has been in use (see page 56). Replace the lamp if it's close to 1700 hours.

Solving Remote Control Problems

The projector doesn't respond to remote control commands.

- Make sure you're within about 30 feet of the projector, and the remote control is not angled away from the projector by more than 30° in any direction.
- You may need to replace the remote control's batteries (see page 50).
- Dim the room lights and turn off any fluorescent lights. Make sure the projector is not in direct sunlight.
- Turn off nearby equipment that emits infrared energy, such as a radiant room heater.

Where To Get Help

EPSON provides technical assistance 24 hours a day at <http://support.epson.com>. Here you can access troubleshooting information, download product documentation, and receive technical advice through e-mail.

To use the EPSON PrivateLine Support service, call (800) 637-7661 and enter the PIN on the EPSON PrivateLine Support card that came with your projector. This is the fastest way of speaking to a live representative, and it's free. This service is available 6 AM to 6 PM, Pacific Time, Monday through Friday, for the duration of your warranty period.

You may also speak with a projector support specialist by dialing one of these numbers:

- U.S.: (562) 276-4394, 6 AM to 6 PM, Pacific Time, Monday through Friday
- Canada: (905) 709-3839, 6 AM to 6 PM, Pacific Time, Monday through Friday

Toll or long distance charges may apply.

Before you call, please have the following information ready:

- Product name (EPSON PowerLite Cinema 200)
- Product serial number (located on the bottom of the projector)
- Computer configuration, if you're connected to a computer
- Description of the problem

You can purchase screens, carrying cases, or other accessories from EPSON at (800) 873-7766 or by visiting the EPSON Store at www.epsonstore.com (U.S. sales only). In Canada, please call (800) 463-7766 for dealer referral.

Specifications

General

Type of display	Poly-silicon TFT active matrix
Size of LCD panels	0.7 inch (18 mm) wide
Lens	F=2.1 to 2.8, f=21.4 to 31.7 mm
Resolution (native format)	1280 × 720 pixels, 720p
Brightness	1300 ANSI lumens maximum (Dynamic/Living Room color mode)
Color reproduction	24 bit, 16.8 million colors
Contrast ratio	800:1
Image size	30 to 300 inches (0.76 to 7.6 m)
Projection distance	2.9 to 37 feet (0.9 to 11.3 m)
Zoom ratio	1:1.5
Aspect ratio	16:9
Noise level	37 dB (Dynamic/Living Room color mode) 28 dB (Natural/Theatre/sRGB color mode)
Keystone correction	Vertical: -15 to +15°

Lamp

Type	UHE (Ultra High Efficiency)
Power consumption	200 W
Lamp life	Approx. 1700 hours (Dynamic/Living Room color mode) Approx. 3000 hours (Natural/Theatre/sRGB color mode)
Part number	V13H010L28

Remote Control

Range	Approx. 30 feet (10 m)
Batteries	AA × 2

Dimensions

Height	4.5 inches (114 mm)
Width	17.3 inches (440 mm)
Depth	12.6 inches (320 mm)
Weight	11.8 lb. (5.3 kg)

Electrical

Rated frequency	50/60 Hz AC
Power supply	100 to 120 VAC, 3.0 A 200 to 240 VAC, 1.4 A
Power consumption	Operating: 270 W max. Standby: 0.3 W

Environmental

Temperature	Operating: 41 to 95 °F (5 to 35 °C) Storage: 14 to 140 °F (-10 to 60 °C)
Humidity	Operating: 20 to 80% RH, non-condensing Storage: 10 to 90% RH, non-condensing

Safety

United States	FCC 47CFR Part 15B Class B (DoC) UL1950 Rev. 3
Canada	ICES-003 Class B CSA C22.2 No. 950-95 (cUL)
CE Marking	Directive 89/336/EEC EN 55022, EN 55024

Compatible Video Formats

The projector supports analog video in NTSC, PAL, and SECAM formats, and it automatically adjusts to the incoming signal. It can receive these formats as composite video, S-video, or component video—which it accepts through the Video, S-Video, and Input A (Component) ports, respectively.

The projector also supports digital video (SDTV, HDTV) and various monitor display formats. The projector's Input A port accepts SDTV and HDTV in either component video or RGB video format; the Input B port accepts computer monitor signals (analog RGB).

Digital video formats

Format	Signal name	Resolution	Aspect ratio
SDTV	480i	640 × 480	4:3
	480p	640 × 480	4:3
	575i	768 × 576	4:3
	575p	768 × 576	4:3
HDTV	720p	1280 × 720	16:9
	1080i	1920 × 1080	16:9

If you're projecting from a computer, set the computer's video card at a refresh rate (vertical frequency) that's compatible with one of the monitor formats listed below. The frequencies of some computers may not allow images to display correctly.

Computer monitor formats

Format	Resolution	Refresh rate (Hz)
VGA	640 × 480	60
VESA	640 × 480	72, 75, 85
SVGA	800 × 600	60, 72, 75, 85, iMac
XGA	1024 × 768	43, 60, 70, 75, 85, iMac
SXGA	1280 × 1024	60
MAC13"	640 × 480	67
MAC16"	832 × 624	75
MAC19"	1024 × 768	75
MAC21"	1152 × 870	75

Aspect Ratio Settings

Images can be automatically resized to display at the projector's native resolution (1280 × 720) when the Aspect setting is set to Auto. If necessary, you can select a different Aspect setting to optimize the image (see page 23). The resolution at which the image displays for a given setting depends on the currently active picture source, as listed below.

Analog TV

Format	Aspect setting				
	Normal	Zoom	Squeeze	Through	Squeeze Through
NTSC	960 × 720	1280 × 720	1280 × 720	596 × 446	794 × 446
PAL or SECAM	960 × 720	960 × 720	960 × 720	708 × 528	944 × 528

Digital component video

Format	Signal name	Aspect setting				
		Normal	Zoom	Squeeze	Through	Squeeze Through
SDTV	480i	960 × 720	1280 × 720	1280 × 720	596 × 446	794 × 446
	480p	960 × 720	1280 × 720	1280 × 720	596 × 446	794 × 446
	575i	960 × 720	1280 × 720	1280 × 720	708 × 528	944 × 528
	575p	960 × 720	1280 × 720	1280 × 720	708 × 528	944 × 528
HDTV	720p	1280 × 720	—	—	1176 × 664	—
	1080i	1280 × 720	—	—	—	—

Digital RGB video

Format	Signal name	Aspect setting				
		Normal	Zoom	Squeeze	Through	Squeeze Through
SDTV	480i	960 × 720	1280 × 720	1280 × 720	640 × 480	853 × 480
	480p	960 × 720	1280 × 720	1280 × 720	640 × 480	853 × 480
	575i	960 × 720	1280 × 720	1280 × 720	768 × 576	1024 × 576
	575p	960 × 720	1280 × 720	1280 × 720	768 × 576	1024 × 576
HDTV	720p	1280 × 720	—	—	1280 × 720	—
	1080i	1280 × 720	—	—	—	—

Computer monitor formats (analog RGB)

Format	Aspect setting				
	Normal	Zoom	Squeeze	Through	Squeeze Through
VGA	960 × 720	1280 × 720	1280 × 720	640 × 480	853 × 480
VESA	960 × 720	1280 × 720	1280 × 720	640 × 480	853 × 480
SVGA	960 × 720	1280 × 720	1280 × 720	800 × 600	1066 × 600
XGA	960 × 720	1280 × 720	1280 × 720	—	—
SXGA	960 × 720	1280 × 720	1280 × 720	—	—
MAC13"	960 × 720	1280 × 720	1280 × 720	640 × 480	853 × 480
MAC16"	960 × 720	1280 × 720	1280 × 720	832 × 624	1109 × 624
MAC19"	960 × 720	1280 × 720	1280 × 720	—	—
MAC21"	954 × 720	1280 × 720	1280 × 720	—	—



Pixelworks DNX™ ICs are used in this projector.

Notices

Important Safety Information

Follow these safety instructions when setting up and using the projector:

- Never look into the projector lens when the lamp is turned on; the bright light can damage your eyes. Never let children look into the lens when it is on.
- Never open any cover on the projector, except the lamp and filter covers. Dangerous electrical voltages inside the projector can severely injure you.
- Except as specifically explained in this *User's Guide*, do not attempt to service this product yourself. Refer all servicing to qualified service personnel.
- The projector and its accessories come packaged in plastic bags. Keep plastic bags away from small children to avoid any risk of suffocation.
- Don't place the projector on an unstable cart, stand, or table. Also, don't use the projector near water or sources of heat.
- Use the type of power source indicated on the projector. If you're not sure of the power available, consult your dealer or power company.
- Place the projector near a wall outlet where the plug can be easily unplugged.
- Don't insert the plug into an outlet with dust present, and insert the plug firmly into the outlet. Failure to do so could result in sparks or fire.
- Don't overload wall outlets, extension cords, or integral convenience receptacles. This can cause fire or electric shock.
- Don't block the slots and openings in the projector case. They provide ventilation and prevent the projector from overheating. Don't operate the projector on a sofa, rug, or other soft surface, or in a closed-in cabinet unless proper ventilation is provided.
- Never push objects through the cabinet slots or spill liquid into the projector.
- Unplug the projector from the wall outlet and refer servicing to qualified service personnel under the following conditions: when the power cord or plug is damaged or frayed; if liquid has been spilled into the projector, or if it has been exposed to rain or water; if it doesn't operate normally when you follow the operating instructions, or if it exhibits a distinct change in performance, indicating a need for service; if it has been dropped or the housing has been damaged.

- Don't place the projector where the cord can be walked on. This may result in fraying or damage to the plug.
- Unplug the projector from the wall outlet before cleaning. Use a damp cloth for cleaning. Do not use liquid or aerosol cleaners.
- This product includes a lamp component that contains mercury. Please consult your state and local regulations regarding proper disposal or recycling, and do not place in the trash.
- Unplug the projector during lightning storms or when not in use for extended periods.
- Don't place the projector or remote control on top of heat-producing equipment.
- If you use the projector in a country other than where you purchased it, use the correct power cord for that country.
- Don't stand on the projector or place heavy objects on it.
- Don't use the projector outside of the required temperature range of 41 to 95 °F (5 to 35 °C). Doing so may cause an unstable display and could lead to projector damage.
- Don't store the projector outside of the required temperature range of 14 to 140 °F (-10 to 60 °C) or in direct sunlight for long periods of time. Doing so may cause damage to the case.

Remote Control Information

You can operate the projector by remote control via a line-of-sight infrared (IR) receiver at the front and rear of the projector. The projector may not respond to remote control commands under the following conditions:

- There is an object between the remote control and the IR receiver on the projector.
- Ambient light is too bright.
- Certain types of fluorescent lighting are used.
- Other equipment that emits infrared energy, such as a radiant room heater, is in the room.

If you experience problems, try the following:

- The remote control's batteries may be low on power; replace them.
- Dim the ambient lighting and/or turn off any fluorescent lights.
- Close any window coverings and/or move the projector out of direct sunlight.
- Turn off other equipment that emits infrared energy.

FCC Compliance Statement

For United States Users

This equipment has been tested and found to comply with the limits for a Class B digital device, pursuant to Part 15 of the FCC Rules. These limits are designed to provide reasonable protection against harmful interference in a residential installation. This equipment generates, uses, and can radiate radio frequency energy and, if not installed and used in accordance with the instructions, may cause harmful interference to radio or television reception. However, there is no guarantee that interference will not occur in a particular installation. If this equipment does cause interference to radio and television reception, which can be determined by turning the equipment off and on, the user is encouraged to try to correct the interference by one or more of the following measures:

- Reorient or relocate the receiving antenna.
- Increase the separation between the equipment and receiver.
- Connect the equipment into an outlet on a circuit different from that to which the receiver is connected.
- Consult the dealer or an experienced radio/TV technician for help.

WARNING

The connection of a non-shielded equipment interface cable to this equipment will invalidate the FCC Certification of this device and may cause interference levels which exceed the limits established by the FCC for this equipment. It is the responsibility of the user to obtain and use a shielded equipment interface cable with this device. If this equipment has more than one interface connector, do not leave cables connected to unused interfaces. Changes or modifications not expressly approved by the manufacturer could void the user's authority to operate the equipment.

For Canadian Users

This Class B digital apparatus meets all requirements of the Canadian Interference-Causing Equipment Regulations.

Declaration of Conformity

According to 47CFR, Part 2 and 15 for Class B Personal Computers and Peripherals; and/or CPU Boards and Power Supplies used with Class B Personal Computers:

We: EPSON AMERICA, INC.
Located at: 3840 Kilroy Airport Way
MS 3-13
Long Beach, CA 90806-2469
Telephone: (562) 290-5254

Declare under sole responsibility that the product identified herein, complies with 47CFR Part 2 and 15 of the FCC rules as a Class B digital device. Each product marketed is identical to the representative unit tested and found to be compliant with the standards. Records maintained continue to reflect the equipment being produced can be expected to be within the variation accepted, due to quantity production and testing on a statistical basis as required by 47CFR §2.909. Operation is subject to the following two conditions: (1) this device may not cause harmful interference, and (2) this device must accept any interference received, including interference that may cause undesired operation.

Trade Name: EPSON
Type of Product: Projector
Model: EMP-TW200
Marketing Name: PowerLite Cinema 200

EPSON AMERICA, INC., LIMITED WARRANTY

What Is Covered: Epson America, Inc. (“EPSON”) warrants to the original end user customer that the EPSON product enclosed with this limited warranty statement, if purchased and used in the United States or Canada, conforms to the manufacturer’s specifications and will be free from defects in workmanship and materials for a period of two (2) years from the date of original purchase (except that the warranty period is 90 days for projector lamps). For warranty service, you must provide proof of the date of original purchase.

What EPSON Will Do To Correct Problems: Should your EPSON projector require service during the warranty period, EPSON will, at its option, exchange or repair the projector without charge for parts or labor. If EPSON authorizes an exchange for the defective unit, EPSON will ship a replacement projector to you, freight prepaid, to an address in Canada or the U.S. (excluding Puerto Rico and U.S. Possessions). Shipments to other locations will be made freight collect. You are responsible for securely packaging the defective unit and returning it to EPSON within five (5) working days of receipt of the replacement. EPSON requires a debit or credit card number to secure the cost of the replacement projector in the event that you fail to return the defective one. If your projector is being repaired by carry-in warranty service, please bring the product securely packaged in its original container or an equivalent to your EPSON Dealer or EPSON Customer Care Center. EPSON will, at its option,

repair or replace on an exchange basis the defective unit, without charge for parts or labor. When warranty service involves the exchange of the product or of a part, the item replaced becomes EPSON property. The exchanged product or part may be new or previously repaired to the EPSON standard of quality, or, at EPSON's option, may be another model of like kind and quality. Exchange or replacement products assume the remaining warranty period of the product covered by this limited warranty, except that each replacement lamp carries the limited 90-day warranty stated above.

What This Warranty Does Not Cover: This warranty covers only normal use of the product in the United States and Canada. 24-hour-per-day use of this product causes unusual strain and is not considered normal use. This warranty does not cover consumables (e.g., fuses), other than lamps. This warranty does not apply to refurbished or reconditioned products, and this warranty is not transferable. EPSON is not responsible for warranty service should the EPSON label or logo or the rating label or serial number be removed or should the product fail to be properly maintained or fail to function properly as a result of misuse, abuse, improper installation, neglect, improper shipping, damage caused by disasters such as fire, flood, and lightning, improper electrical current, software problems, interaction with non-EPSON products, or service other than by an EPSON Authorized Servicer. Postage, insurance, or shipping costs incurred in presenting your EPSON product for carry-in warranty service are your responsibility. If a claimed defect cannot be identified or reproduced in service, you will be held responsible for costs incurred.

THE WARRANTY AND REMEDY PROVIDED ABOVE ARE EXCLUSIVE AND IN LIEU OF ALL OTHER EXPRESS OR IMPLIED WARRANTIES INCLUDING, BUT NOT LIMITED TO, THE IMPLIED WARRANTIES OF MERCHANTABILITY OR FITNESS FOR A PARTICULAR PURPOSE. SOME LAWS DO NOT ALLOW THE EXCLUSION OF IMPLIED WARRANTIES. IF THESE LAWS APPLY, THEN ALL EXPRESS AND IMPLIED WARRANTIES ARE LIMITED TO THE WARRANTY PERIOD IDENTIFIED ABOVE. UNLESS STATED HEREIN, ANY STATEMENTS OR REPRESENTATIONS MADE BY ANY OTHER PERSON OR FIRM ARE VOID. EXCEPT AS PROVIDED IN THIS WRITTEN WARRANTY, NEITHER EPSON AMERICA, INC. NOR ITS AFFILIATES SHALL BE LIABLE FOR ANY LOSS, INCONVENIENCE, OR DAMAGE, INCLUDING DIRECT, SPECIAL, INCIDENTAL OR CONSEQUENTIAL DAMAGES, RESULTING FROM THE USE OR INABILITY TO USE THE EPSON PRODUCT, WHETHER RESULTING FROM BREACH OF WARRANTY OR ANY OTHER LEGAL THEORY. IF THE REMEDY ABOVE FAILS, EPSON'S ENTIRE LIABILITY SHALL BE LIMITED TO A REFUND OF THE PRICE PAID FOR THE EPSON PRODUCT COVERED BY THIS LIMITED WARRANTY.

In Canada, warranties include both warranties and conditions.

Some jurisdictions do not allow limitations on how long an implied warranty lasts, and some jurisdictions do not allow the exclusion or limitation of incidental or consequential damages, so the above limitations and exclusions may not apply to you. This warranty gives you specific legal rights, and you may also have other rights, which vary from jurisdiction to jurisdiction.

To locate the Authorized EPSON Servicer nearest you, call the EPSON ConnectionSM at (800) 637-7661 + PIN or (562) 276-4394 in the U.S. and (905) 709-3839 in Canada, or write to: Epson America, Inc., P.O. Box 93012, Long Beach, CA 90809-3012.

Index

A

- Accessories, 10, 61
- Air filter
 - cleaning and replacing, 51
 - ordering, 10
- Anti-theft device, 8, 10
- Aspect button, 9, 23, 59
- Aspect ratio, selecting, 23, 66 to 67

B

- Background Color setting, 36
- Batteries, changing, 50
- Black level, 30
- Blank button, 9, 22
- Blurry picture, 60
- Brightness
 - setting, 29
 - specification, 63

C

- Cables, connecting, 15 to 17
- Child lock, 25
- Cinema Color Editor
 - setting up, 39 to 41
 - using, 42 to 48
- Cleaning
 - air filter, 51
 - lens and projector case, 49
- Color
 - adjusting, 31, 44 to 45
 - problems, 60
- Color Mode, 9, 24, 60
- Color Temp setting, 31
- COM Port setting, 37
- Computer, displaying an image, 57 to 58

- Contrast ratio, 63
- Contrast setting, 29
- Control panel, projector, 9

D

- Declaration of Conformity, 72
- Desktop adapter, Macintosh, 10
- Documentation, 11

E

- Electrical requirements, 64
- EPSON
 - accessories, 10, 61
 - Home Service, 7
 - PrivateLine Support, 61
 - technical support, 11, 61
 - warranty, 7, 72 to 73

F

- FCC Compliance Statement, 71
- Feet, adjustable, 19
- Filter, *see* Air filter
- Flesh Tone setting, 31
- Flickering, 30, 59
- Focus adjustment, 17

G

- Gain, color, 31
- Gamma, 31

H

Help, 61
Home Service, 7

I

Image
adjusting, 17 to 19, 29 to 32, 44 to 45
changing aspect ratio, 23, 66 to 67
positioning, 19, 35
resizing, 23, 35
selecting source, 22
upside-down or backwards, 18
Image problems, 57 to 60
Info menu, 56
Input Signal setting, 18, 37
Interference, signal, 30, 59
Interlaced mode setting, 30

K

Kensington anti-theft device, 8, 10
Keystone buttons, 9
Keystone correction, 13, 19, 59

L

Lamp
checking usage timer, 56
life, 63
ordering, 10, 52
replacing, 52 to 53
resetting usage timer, 53
safety instructions, 69 to 70
specifications, 63
Language setting, 28
Lens shift knobs, 19
Lens, cleaning, 49
Lights, projector, 55 to 56
Lock
Kensington, 8, 10
settings, 25

M

Macintosh desktop adapter, 10
Memory button, 9, 33
Memory settings
creating, 33, 46
deleting, 34, 48
renaming, 48
using, 33, 47
Menu button, 9, 27
Menus
available settings, 28 to 37
customizing, 28
using, 27
Message setting, 36
Moving projector, 54

N

No image, 57 to 58
Noise reduction, 30

O

Offset, 31
Output scaling, 35

P

Picture problems, 57 to 60
Pixelworks, 7, 67
Positioning image, 19
Positioning projector, 13 to 14
Problems
picture, 57 to 60
remote control, 60, 70
Progressive mode setting, 30
Projection distance, 14, 63

Projector
 checking status, 56
 cleaning, 49
 control panel, 9
 dimensions, 64
 feet, 19
 lights, 55 to 56
 locking, 8, 10, 25
 menus, 28 to 37
 parts, 8
 positioning, 13 to 14
 resetting menu options, 34
 storing, 54
 transporting, 54
 turning on and off, 21 to 22, 57

R

Registration, 7
Remote control
 buttons, 9
 changing batteries, 50
 lighting up buttons, 22
 problems, 60, 70
Replacing lamp, 52 to 53
Resetting
 lamp usage timer, 34, 53
 memory settings, 34, 48
 projector settings, 34
Resolution
 compatible formats, 65
 projector, 63
RGB settings, 31, 45
RGBCMY settings, 45
RS-232C (serial) cable, 37, 41

S

Safety approvals, 64
Safety instructions, 69 to 70
Serial cable, 37, 41
Setup level, 29
Sharpness, 30
Sleep mode, 37

Source buttons, 9
Source, selecting image, 22
Specifications
 compatible video formats, 65
 electrical, 64
 environmental, 64
 general, 63
 lamp, 63
 remote control, 63
Squeeze mode, 23
Startup screen, selecting, 36
Static, 59
Storing projector, 54
Support, *see* Technical support
Sync (Synchronization) setting, 32

T

Technical support, 11, 61
Through setting, 23
Tint, 31
Tracking, 32
Transporting projector, 54
Trigger Out setting, 37
Trigger port, 17
Turning on and off projector, 21 to 22, 57

U

USB cable, 37, 41

V

Video, compatible formats, 65

W

Warranty, 7, 72 to 73
Where to Get Help, 61
White level, 30

Z

Zoom adjustment, 17

Zoom Caption setting, 23, 35

Zoom setting, 23

